



This work is licensed under a Creative Commons Attribution License (CC BY 4.0).

Research article

[urn:lsid:zoobank.org:pub:FDA7A52D-404E-4E50-A519-AF1300D8F435](https://zoobank.org/pub/FDA7A52D-404E-4E50-A519-AF1300D8F435)

**Integrative taxonomy resuscitates two species in the
Lasioglossum villosulum complex (Kirby, 1802)
(Hymenoptera: Apoidea: Halictidae)**

Alain PAULY^{1,*}, Grégoire NOËL², Gontran SONET³,
David G. NOTTON⁴ & Jean-Luc BOEVÉ⁵

^{1,3,5}Royal Belgian Institute of Natural Sciences, O.D. Taxonomy and Phylogeny & JEMU,
rue Vautier 29, B-1000 Brussels, Belgium.

²Functional and Evolutionary Entomology, University of Liège - Gembloux Agro-Bio Tech,
Passage des Déportés 2, B-5030 Gembloux, Belgium.

⁴Department of Life Sciences, Insects Division, Darwin Centre - Room 315,
The Natural History Museum, Cromwell Road, London, SW7 5BD, United Kingdom.

*Corresponding author: apauly@naturalsciences.be; alain.pauly54@gmail.com

²Email: gregoire.noel@uliege.be; gregoirenoel@hotmail.com

³Email: gsonet@naturalsciences.be

⁴Email: d.notton@nhm.ac.uk

⁵Email: jboeve@naturalsciences.be

¹[urn:lsid:zoobank.org:author:3953442F-F55E-45C6-BD0E-12C0E19F34FF](https://zoobank.org/author/3953442F-F55E-45C6-BD0E-12C0E19F34FF)

²[urn:lsid:zoobank.org:author:886A4F27-E95B-4870-9B9F-02586DF75D4C](https://zoobank.org/author/886A4F27-E95B-4870-9B9F-02586DF75D4C)

³[urn:lsid:zoobank.org:author:BA7353F8-5296-4968-9D2D-D474EF8FCEB6](https://zoobank.org/author/BA7353F8-5296-4968-9D2D-D474EF8FCEB6)

⁴[urn:lsid:zoobank.org:author:2E452EF2-703C-47C0-8432-6AB9C05AC06A](https://zoobank.org/author/2E452EF2-703C-47C0-8432-6AB9C05AC06A)

⁵[urn:lsid:zoobank.org:author:23C76CDF-A462-420F-8391-18DA44ADF086](https://zoobank.org/author/23C76CDF-A462-420F-8391-18DA44ADF086)

Abstract. Morphological and allozyme analyses suggested the occurrence of a pseudocryptic species in the *Lasioglossum villosulum* (Kirby, 1802) species complex (Hymenoptera: Halictidae). We analysed the morphology of more than 1500 specimens and the DNA barcode fragment of the cytochrome *c* oxidase subunit I (COI) of 102 specimens of this species complex from several Palaearctic countries. Our phylogenetic tree reconstructions, based on maximum likelihood and Bayesian inference revealed one clade corresponding to all specimens morphologically identified as *Lasioglossum medinai* (Vachal, 1895) and one divergent specimen morphologically identified as *Lasioglossum berberum* (Benoist, 1941). The other specimens, morphologically identified as *L. villosulum*, aggregated into at least three other lineages in our phylogenetic trees. The tree-based species delineations methods based on the Generalized Mixed Yule Coalescent (GMYC) model and the Bayesian Poisson Tree Process (bPTP) identified five to ten candidate species within the *L. villosulum* species complex, with *L. medinai* and *L. berberum* consistently recognized as separated from all other candidate species. Diagnostic morphological differences were found among *L. medinai*, *L. berberum* and the remaining specimens identified as *L. villosulum*. No diagnostic morphological differences were found to distinguish the different phylogenetic candidate species or lineages found within *L. villosulum* and *L. medinai*. Thus,

both genetic and morphological approaches support the existence of *L. medinai* and *L. berberum* as distinct species from *L. villosulum*.

Keywords. Bees, Palearctic, COI, phylogeny, morphology, integrative taxonomy, cryptic species.

Pauly A., Noël G., Sonet G., Notton D.G. & Boevé J.-L. 2019. Integrative taxonomy resuscitates two species in the *Lasioglossum villosulum* complex (Kirby, 1802) (Hymenoptera: Apoidea: Halictidae). *European Journal of Taxonomy* 541:1–43. <https://doi.org/10.5852/ejt.2019.541>

Introduction

Integrative taxonomy is efficient in classifying pseudocryptic species, that is, species recognizable by a few apparent, subtle, morphological criteria once their existence is revealed by other methods (Padial *et al.* 2010; Lajus *et al.* 2015; Kress *et al.* 2015; Struck *et al.* 2017). DNA barcodes combined with morphological, ecological, and geographical data are powerful to detect cryptic species, to clarify species boundaries, and to estimate bee species diversity (Pauly *et al.* 2015; Schmidt *et al.* 2015; Bossert *et al.* 2016; Gonzales-Vaquero *et al.* 2016; Gibbs 2018; Landaverde-González *et al.* 2017; Praz *et al.* 2019; Ferrari 2019). Integrative taxonomy can also contribute to synonymize species (e.g. González-Vaquero & Roig-Alsina 2019).

The *Lasioglossum villosulum* (Kirby, 1802) species complex is a highly variable group of halictid bees, widespread throughout the Palearctic (Fig. 1). The nominal subspecies (Fig. 2A, B) is widely distributed from the Azores to Mongolia, from the Canary Islands to Egypt, and north to Finland. The subspecies *trichopse* (Strand, 1914) occurs from Japan to Manchuria, Taiwan and Malaysia. The subspecies *arabicum* Ebmer, 2008 (Fig. 2E, F) is endemic to the Arabian Peninsula (Ebmer 1988, 2008). The biology of *L. villosulum* was studied in detail by Plateaux-Quénu & Plateaux (1981, 1985, 1986, 1987, 1993), Plateaux-Quénu *et al.* (1987), and Plateaux-Quénu (1993). These authors report the presence of larger females inhabiting the south of France (Fig. 2C, D). On the basis of an electrophoretic analysis

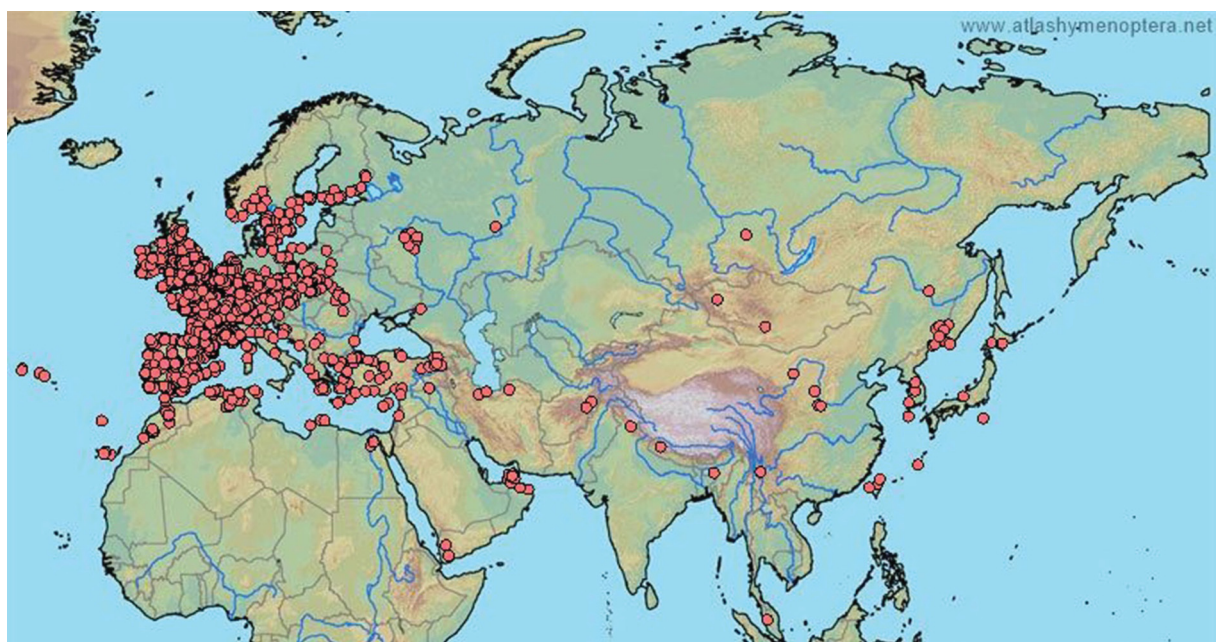

Fig. 1. Distribution of *Lasioglossum villosulum* (Kirby, 1802) throughout the Palearctic and Oriental Regions.

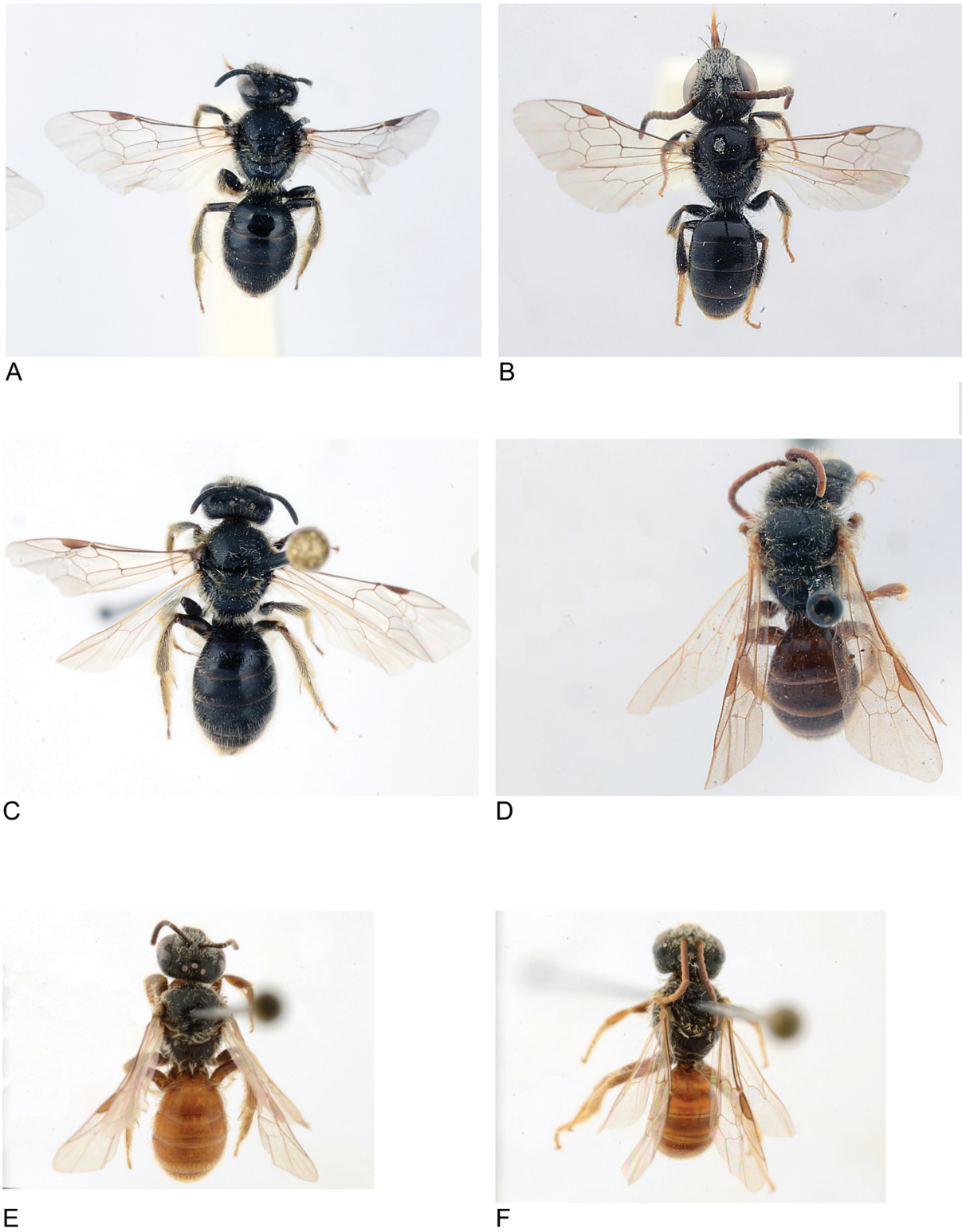

Fig. 2. Colouration and relative size of the species and subspecies. **A–B.** *Lasioglossum villosulum* (Kirby, 1802), ♀ and ♂. **C–D.** *L. medinai* (Vachal, 1895), ♀ and ♂ (holotype). **E–F.** *L. villosulum arabicum* Ebmer, 2008, ♀ and ♂.

of allozymes, Packer *et al.* (1999) conclude that these unusually large individuals belong to a new species, but without naming it, and they write: “a formal description of the new species will be presented elsewhere pending additional surveys of museum collections from a wider range of localities and detailed examination of male specimens”, but their description was never published. As in other specific complex, *Andrena bicolor* (Praz *et al.* 2019) or *Bombus lucorum* (Bossert *et al.* 2016), combination of morphological character and genetic analysis of *L. villosulum* could also reveal distinctive species.

The objective of this study is to analyse the morphology and a DNA barcode fragment of the cytochrome *c* oxidase subunit I (COI) gene of specimens previously identified as *L. villosulum* from various localities from the Palaearctic, with a focus on Europe and the Mediterranean Basin, and to evaluate if larger females collected from the south of France, Israel and Spain belong to a separate species or not. If our results show the existence of a hitherto undescribed species, our aim is, either to resurrect a name among the eight synonyms of *L. villosulum* listed by Ebmer (1988), or to give a new name to this species.

Material and methods

Repositories

The morphological analysis is based on the examination of specimens of the *Lasioglossum villosulum* complex preserved in the following institutes as well as the private collections mentioned in the acknowledgements:

AMNH	=	American Museum of Natural History, New York, USA
GABT	=	Gembloux Agro-Bio Tech, Gembloux, Belgium
HUJ	=	Hebrew University of Jerusalem, Rehovot, Israel
INRA	=	National Institute of Agronomic Research, Avignon, France
MNCN	=	Museo Nacional de Ciencias Naturales, Madrid, Spain
MNHN	=	Museum national d’Histoire naturelle, Paris, France
MNHUB	=	Museum für Naturkunde an der Humboldt Universität, Berlin, Germany
NHMUK	=	Natural History Museum, London, UK, formerly the British Museum (Natural History)
RBINS	=	Royal Belgian Institute of Natural Sciences, Brussels, Belgium
SDEI	=	Senckenberg Deutsches Entomologisches Institut, Müncheberg, Germany
SMF	=	Senckenberg Museum, Frankfurt am Main, Germany

Specimens examined

We re-examined all the types necessary to establish the oldest name of the pseudocryptic species as *L. medinai* (Vachal, 1895), the oldest synonym from southern Europe with a description corresponding potentially to the unusually large pseudocryptic species. Ebmer (1988) has examined all the types and we follow him for synonymy where we did not examine the types.

NHMUK specimens were assigned unique specimen numbers. Specimen data and images for NHMUK specimens were recorded on the NHMUK database and are publically available through the NHMUK Data Portal (Natural History Museum 2014).

For DNA analysis, we collected 22 female specimens (Table 1) of *Lasioglossum villosulum* including larger specimens of the presumed new species and representing the widest possible distribution coverage (i.e., representing the maximum number of countries).

DNA extraction

We used the NucleoSpin® Tissue Kit (Macherey-Nagel, Germany) to extract genomic DNA, following the manufacturer’s protocol but eluting the DNA in 80 µl elution buffer. If possible, one middle leg per specimen was chosen to prepare samples, and the rest of the specimen was preserved as voucher.

Table 1. Information of sequenced specimens used in the present study.

Code	Species	Locality	Date	Leg.	Primers (F/R)	GenBank
AP222	<i>Lasioglossum bluethgeni</i> Ebmer, 1971	Greece, Pieria, Mt Olympus	2013	leg. Minachilis	BarbeeF/MtD9	MK388879
AP231	<i>Lasioglossum villosulum</i> (Kirby, 1802)	France, Rhône, St Jean d'Ardières	2012	leg. C.B. Olémé	LCO1490/HCO2198	MK388880
AP232	<i>Lasioglossum villosulum</i>	France, Charente Maritime, Saintes	2012	leg. N. Sérès	LCO1490/HCO2198	MK388881
AP233	<i>Lasioglossum villosulum</i>	France, Allier, Commentry	2013	leg. E. Van de Pitte	LCO1490/HCO2198	MK388882
AP234	<i>Lasioglossum villosulum</i>	France, Orne, Sées	2011	leg. D. Paris	LCO1490/HCO2198	MK388883
AP235	<i>Lasioglossum villosulum</i>	France, Rhône, Lyon	2013	leg. F. Vyghen	LCO1490/HCO2198	MK388884
AP236	<i>Lasioglossum villosulum</i>	Spain, Almeria, Almerimar	2014	leg. A. Pauly	BarbeeF/MtD9	MK388885
AP237	<i>Lasioglossum villosulum</i>	Belgium, Brussels, Angleur	2014	leg. A. Pauly	LCO1490/HCO2198	MK388886
AP238	<i>Lasioglossum villosulum</i>	Belgium, Brussels, Auderghem	2015	leg. A. Pauly	LCO1490/HCO2198	MK388887
AP239	<i>Lasioglossum villosulum</i>	Algeria, Guelma, El Fedjoudj	2016	leg. A. Laouar	BarbeeF/MtD9	MK388888
AP240	<i>Lasioglossum villosulum</i>	Algeria, Batna, Lahrayek	2015	leg. H. Chichoune	LCO1490/HCO2198	MK388889
AP241	<i>Lasioglossum medinai</i> (Vachal, 1895)	France, Lot, Le Montat	2012	leg. P. Christophe	BarbeeF/MtD9	MK388890
AP242	<i>Lasioglossum medinai</i>	France, Charente Maritime, Saintes	2012	leg. N. Sérès	LCO1490/HCO2198	MK388891
AP243	<i>Lasioglossum medinai</i>	France, Drôme, Saint-Gervais sur Roubion	2007	leg. G. de Premorel	BarbeeF/MtD9	MK388892
AP245	<i>Lasioglossum medinai</i>	France, Rhône, Lyon	2011	leg. L. Motino	BarbeeF/MtD9	MK388893
AP247	<i>Lasioglossum medinai</i>	France, Aude, Arzens Bellevue	2014	leg. D. Genoud	LCO1490/HCO2198	MK388894
AP249	<i>Lasioglossum medinai</i>	Israel, Judean foothills, Mevo Horon	2011	leg. Y. Mandelik	LCO1490/HCO2198	MK388895
AP250	<i>Lasioglossum villosulum</i>	Spain, Almeria, Almerimar	2014	leg. A. Pauly	BarbeeF/MtD9	MK388896
AP257	<i>Lasioglossum berberum</i> (Benoist, 1941)	Algeria, Biskra, Dar Arous	2009	Leg. H. Djouama	LCO1490/HCO2198	MK388901
AP391	<i>Lasioglossum medinai</i>	France, Saint-Marcel-sur-Aude, Le Four à Cahux	2014	leg. D. Genoud	BarbeeF/MtD9	MK388897
AP392	<i>Lasioglossum medinai</i>	Spain, Segovia, Rio Milanillos	2012	leg. Ortiz-Sanchez	BarbeeF/MtD9	MK388898
AP393	<i>Lasioglossum medinai</i>	France, Cléré-sur-layon, La Paguerie	2013	leg. O. Durand	BarbeeF/MtD9	MK388899
AP394	<i>Lasioglossum medinai</i>	France, Vaucluse, Cucuron	2005	leg. G. Carré	BarbeeF/MtD9	MK388900

DNA amplification

Two pairs of primers were used to amplify the 5' end of the cytochrome *c* oxidase subunit I (COI) mitochondrial gene (the standard DNA barcode region for animals). Primers LCO1490 and HCO2198 (Folmer *et al.* 1994) were used first on all specimens and, when amplification failed or the sequence was not valid (contamination or multiple peaks), a second primer pair, BarBeeF (Françoso & Arias 2013) and MtD9 (Simon *et al.* 1994) was used (Table 1). Each reaction of 25 µl contained 2 µl of DNA template, 0.03 U/µl of Platinum® Taq DNA Polymerase (Life Technologies, USA), 1X PCR buffer, 0.2 mM dNTPs, 0.4 µM of each primer and 1.5 mM MgCl₂ as used in Pauly *et al.* (2015). PCR profile for the first set of primers began with 3 min at 94°C, then 40 cycles of 30 s at 94°C, 30 s at 48°C and 45 s at 72°C and finished with 7 min at 72°C. For the second set of primers, the PCR profile was: 3 min at 94°C, 5 cycles of 30 s at 94°C, 30 s at 45°C and 45 s at 72°C and then 35 cycles of 30 s at 94°C, 30 s at 48°C and 45 s at 72°C. This profile finished with 7 min at 72°C.

DNA sequencing

PCR products were sequenced in both directions with an ABI 3130xl sequencer using BigDye® Terminator ver. 3.1 Cycle Sequencing Kit (Life Technologies, USA). The contigs obtained from both primers were assembled, checked, edited and trimmed in CodonCode Aligner® ver. 5.0.1 (CodonCode Corp., Centerville, Massachusetts). Consensus sequences were produced for all bees sampled and they ranged between 412 bp and 676 bp. A BLAST search was performed for all of them in order to detect and exclude obvious contaminations.

Molecular and phylogenetic analysis

All 22 sequences obtained here (with accession numbers from MK388879 to MK388901) were merged with all 80 additional unique barcode sequences retrieved from GenBank and BOLD (using keywords “*Lasioglossum villosulum* COI” and “*Lasioglossum villosulum*”, respectively, on 23 January 2018) and with barcode data provided by Professor Laurence Packer from BOLD on November 2018 (Table 2). One barcode of *Lasioglossum bluethgeni*, a halictid belonging to the subgenus *Evyllaesus* Robertson, 1902 (AP222; Table 1), was added as outgroup to root phylogenetic trees. All COI sequences were aligned using ClustalW (Larkin *et al.* 2007) with the default parameters implemented and pairwise deletion for gaps treatment in MEGA ver. 7.0.21 (Kumar *et al.* 2016). After quality control of all barcodes, the obtained alignment included at most 658 nucleotide characters. For a first distance-based analysis, pairwise p-distances (i.e., proportion of variable sites) were computed and a Neighbour-Joining (NJ) tree was reconstructed with MEGA ver. 7.0.21 with bootstrap pseudo-replicates (n = 1000).

For phylogenetic analysis, we extracted the unique haplotypes from the DNA sequence dataset obtained above using the *ape* (Paradis & Schliep 2018) and *pegas* (Paradis 2010) packages in RStudio ver. 3.5.1 (2018). Label details of each haplotype are given in Table 3. Maximum likelihood (ML) and Bayesian inference (BI) methods were conducted using GARLI ver. 2.1 (Zwickl 2006) and Mr Bayes ver. 3.2.6 (Ronquist *et al.* 2012), respectively. The best substitution model for each codon position (1st, 2nd and 3rd codon position) was searched using PartitionFinder2 ver. 2.1.1 (Lanfear *et al.* 2017), with linked branch lengths parameter, the AICc model selection metrics and the greedy search algorithm (Lanfear *et al.* 2012). The chosen models for partitioned codon position of COI were: TIM+G (1st), TrN+I (2nd) and F81+I (3rd). For ML analysis, we configured a group of independent runs: 10 runs for conducting bootstrapping (ntotal = 1000; n/run = 100) and another run for searching the best ML tree. A random unconstrained starting tree was used for each run and automated stopping criterion was applied: when ln score remained constant for 10000 consecutive generations for bootstrap calculation and 100000 consecutive generations for the best ML tree with a required score improvement for topology of minimum 0.01 and 0.00001, respectively. The set of ML trees generated in GARLI (best ML tree + 10 ML trees resulting from the ten bootstrapping runs treesmethod in Newick format) were summarized

Table 2. Barcodes sequences of *Lasioglossum villosulum* (Kirby, 1802) retrieved from GenBank and BOLD with their accession number or BOLD process ID, collection country and reference.

GenBank/BOLD	Country	Reference	GenBank/BOLD	Country	Reference
AF104642	France	Danforth 1999	BEEEE059-15	England	Tang <i>et al.</i> 2018
AF435364	Spain	Danforth 2002	BEEEE106-15	England	No reference
GU705888	Germany	Schmidt <i>et al.</i> 2015	BEEEE326-16	England	No reference
JQ909783	Ireland	Magnacca & Brown 2012	GMGMA1113-14	Germany	No reference
JQ909784	Ireland	Magnacca & Brown 2012	GMGMB1509-14	Germany	No reference
JQ909785	Ireland	Magnacca & Brown 2012	GMGMB660-14	Germany	No reference
JQ909786	Ireland	Magnacca & Brown 2012	GMGMC872-14	Germany	No reference
KJ836810	Germany	Schmidt <i>et al.</i> 2015	GMGME202-14	Germany	No reference
KJ836844	Germany	Schmidt <i>et al.</i> 2015	GMGMH624-14	Germany	No reference
KJ836857	Germany	Schmidt <i>et al.</i> 2015	GMGMI1082-14	Germany	No reference
KJ837085	Germany	Schmidt <i>et al.</i> 2015	GMGMI407-14	Germany	No reference
KJ837457	Germany	Schmidt <i>et al.</i> 2015	GMGML649-14	Germany	No reference
KJ837665	Germany	Schmidt <i>et al.</i> 2015	GMGMN583-14	Germany	No reference
KJ837678	Germany	Schmidt <i>et al.</i> 2015	KX824765	Azores (Spain)	Weissman <i>et al.</i> 2017
KJ837833	Germany	Schmidt <i>et al.</i> 2015	KX824766	Azores (Spain)	Weissman <i>et al.</i> 2017
KJ838208	Germany	Schmidt <i>et al.</i> 2015	KX824767	Azores (Spain)	Weissman <i>et al.</i> 2017
KJ838409	Turkey	Schmidt <i>et al.</i> 2015	KX824768	Azores (Spain)	Weissman <i>et al.</i> 2017
KJ838863	Germany	Schmidt <i>et al.</i> 2015	KX824769	Azores (Spain)	Weissman <i>et al.</i> 2017
KJ839019	France	Schmidt <i>et al.</i> 2015	KX824770	Azores (Spain)	Weissman <i>et al.</i> 2017
KJ839155	Germany	Schmidt <i>et al.</i> 2015	JF903563	France	Gibbs <i>et al.</i> 2012
KR931723	Canada	Hebert <i>et al.</i> 2016	ACUFI641-13	Finland	No reference
BCHYM2460-14	Germany	No reference	DLII1641-09	France	No reference
BCHYM2461-14	Germany	No reference	GBMIX809-14	Germany	No reference
BCHYM3040-14	Germany	No reference	GBMIX810-14	Germany	No reference
BCHYM4651-14	Germany	No reference	GMBUC405-14	Bulgaria	No reference
BEECA132-06	Canada	No reference	GMBUE1651-14	Bulgaria	No reference
BEECA133-06	Canada	No reference	GMBUE693-14	Bulgaria	No reference
BEECB254-07	Canada	No reference	GMBUF200-14	Bulgaria	No reference
BEECB255-07	Canada	No reference	GMBUG219-14	Bulgaria	No reference
BEECE374-10	France	No reference	LASNA081-08	France	No reference
BEECF996-13	Canada	No reference	LASNA084-08	France	No reference
BOFMD017-10	Israel	No reference	LASNA089-08	France	No reference
BOWGF1582-10	USA	No reference	LASNA090-08	France	No reference
BOWGF1584-10	USA	No reference	LASNA091-08	France	No reference
BOWGF3178-14	Ukraine	No reference	LASNA092-08	France	No reference
DLII1409-08	Canada	No reference	LASNA743-08	Israel	No reference
DLII1616-09	France	No reference	LASNA837-08	Israel	No reference
DLII1622-09	France	No reference	NOAPI297-14	Norway	No reference
DLII1625-09	France	No reference	NOAPI298-14	Norway	No reference
DLII1627-09	France	No reference	NOAPI299-14	Norway	No reference

Table 3 (continued on next two pages). Haplotype details of 103 COI sequences.

Haplotype	Number of sequences	Sequence labels
I	4	AF104642.1 <i>Lasioglossum villosulum</i> France
		AP236.2 <i>Lasioglossum villosulum</i> Spain
		AP250.2 <i>Lasioglossum villosulum</i> Spain
		KJ837665.1 <i>Lasioglossum villosulum</i> Germany
II	8	AF435364.1 <i>Lasioglossum villosulum</i> Spain
		AP240.1 <i>Lasioglossum villosulum</i> Algeria
		KX824765.1 <i>Lasioglossum villosulum</i> Spain (Azores)
		KX824767.1 <i>Lasioglossum villosulum</i> Spain (Azores)
		KX824768.1 <i>Lasioglossum villosulum</i> Spain (Azores)
		KX824769.1 <i>Lasioglossum villosulum</i> Spain (Azores)
		KX824770.1 <i>Lasioglossum villosulum</i> Spain (Azores)
III	1	JF903563.1 <i>Lasioglossum villosulum</i> France
IV	24	AP222.2 <i>Lasioglossum bluethgeni</i> Greece
		AP231.1 <i>Lasioglossum villosulum</i> France
		AP232.1 <i>Lasioglossum villosulum</i> France
		KJ837085.1 <i>Lasioglossum villosulum</i> Germany
		KJ838208.1 <i>Lasioglossum villosulum</i> Germany
		KJ839019.1 <i>Lasioglossum villosulum</i> France
		GMGMA111314 <i>Lasioglossum villosulum</i> Germany
		GMGMB150914 <i>Lasioglossum villosulum</i> Germany
		GMGMB66014 <i>Lasioglossum villosulum</i> Germany
		GMGMC87214 <i>Lasioglossum villosulum</i> Germany
		GMGME20214 <i>Lasioglossum villosulum</i> Germany
		GMGMH62414 <i>Lasioglossum villosulum</i> Germany
		GMGMI108214 <i>Lasioglossum villosulum</i> Germany
		GMGMI40714 <i>Lasioglossum villosulum</i> Germany
		GMGML64914 <i>Lasioglossum villosulum</i> Germany
		GMGMN58314 <i>Lasioglossum villosulum</i> Germany
		BCHYM3040-14 Hymenoptera Germany
		DLII1616-09 Hymenoptera France
		DLII1622-09 <i>Lasioglossum villosulum</i> France
		DLII1627-09 Hymenoptera France
		GMBUC405-14 Hymenoptera Bulgaria
		GMBUE1651-14 Hymenoptera Bulgaria
		GMBUG219-14 Hymenoptera Bulgaria
		LASNA089-08 <i>Lasioglossum villosulum</i> France
LASNA090-08 <i>Lasioglossum villosulum</i> France		
V	2	AP233.1 <i>Lasioglossum villosulum</i> France
		AP237.1 <i>Lasioglossum villosulum</i> Belgium

Table 3 (continued). Haplotype details of 103 COI sequences.

Haplotype	Number of sequences	Sequence labels
VI	20	AP234.1 <i>Lasioglossum villosulum</i> France
		AP238.1 <i>Lasioglossum villosulum</i> Belgium
		GU705888.1 <i>Lasioglossum villosulum</i> Germany
		KJ836810.1 <i>Lasioglossum villosulum</i> Germany
		KJ836844.1 <i>Lasioglossum villosulum</i> Germany
		KJ836857.1 <i>Lasioglossum villosulum</i> Germany
		KJ837457.1 <i>Lasioglossum villosulum</i> Germany
		KJ838863.1 <i>Lasioglossum villosulum</i> Germany
		BEEEE05915 <i>Lasioglossum villosulum</i> England
		BEEEE10615 <i>Lasioglossum villosulum</i> England
		BEEEE32616 <i>Lasioglossum villosulum</i> England
		BCHYM2460-14 Hymenoptera Germany
		BCHYM2461-14 Hymenoptera Germany
		BCHYM4651-14 Hymenoptera Germany
		BOWGF1584-10 Hymenoptera United States
		GBMIX809-14 Hymenoptera Germany
		GBMIX810-14 Hymenoptera Germany
GMBUF200-14 Hymenoptera Bulgaria		
NOAPI298-14 Hymenoptera Norway		
NOAPI299-14 Hymenoptera Norway		
VII	2	AP235.1 <i>Lasioglossum villosulum</i> France
		KJ837833.1 <i>Lasioglossum villosulum</i> Germany
VIII	1	AP239.2 <i>Lasioglossum villosulum</i> Algeria
IX	10	AP241.3 <i>Lasioglossum medinai</i> France
		AP242.1 <i>Lasioglossum medinai</i> France
		AP243.3 <i>Lasioglossum medinai</i> France
		AP247.1 <i>Lasioglossum medinai</i> France
		AP392.3 <i>Lasioglossum medinai</i> Spain
		AP394.3 <i>Lasioglossum medinai</i> France
		DLII1625-09 Hymenoptera France
		LASNA081-08 <i>Lasioglossum</i> n sp. cpq France
		LASNA091-08 <i>Lasioglossum</i> n sp. cpq France
		LASNA092-08 <i>Lasioglossum</i> n sp. cpq France
X	2	AP245.3 <i>Lasioglossum medinai</i> France
		AP393.3 <i>Lasioglossum medinai</i> France
XI	2	AP249.1 <i>Lasioglossum medinai</i> Israel
		BOFMD017-10 Hymenoptera Israel

Table 3 (continued). Haplotype details of 103 COI sequences.

Haplotype	Number of sequences	Sequence labels
XII	1	AP391.3 <i>Lasioglossum medinai</i> France
XIII	3	JQ909783.1 <i>Lasioglossum villosulum</i> Ireland
		JQ909784.1 <i>Lasioglossum villosulum</i> Ireland
		JQ909785.1 <i>Lasioglossum villosulum</i> Ireland
XIV	1	JQ909786.1 <i>Lasioglossum villosulum</i> Ireland
XV	1	KJ837678.1 <i>Lasioglossum villosulum</i> Germany
XVI	1	KJ838409.1 <i>Lasioglossum villosulum</i> Turkey
XVII	1	KJ839155.1 <i>Lasioglossum villosulum</i> Germany
XVIII	6	KR931723.1 <i>Lasioglossum villosulum</i> Canada
		BEECA132-06 <i>Lasioglossum nr villosulum</i> Canada
		BEECA133-06 <i>Lasioglossum nr villosulum</i> Canada
		BEECF996-13 Hymenoptera Canada
		BOWGF1582-10 Hymenoptera United States
		NOAPI297-14 Hymenoptera Norway
XIX	1	KX824766.1 Spain(Azores)
XX	1	AP257 <i>Lasioglossum berberum</i> Algeria
XXI	1	ACUFI641-13 Hymenoptera Finland
XXII	2	BEECB254-07 <i>Lasioglossum nr villosulum</i> Canada
		BEECB255-07 <i>Lasioglossum nr villosulum</i> Canada
XXIII	1	BEECE374-10 Hymenoptera France
XXIV	2	BOWGF3178-14 Hymenoptera Ukraine
		LASNA743-08 Hymenoptera Israel
XXV	1	DLII1409-08 <i>Lasioglossum nr villosulum</i> Canada
XXVI	1	DLII1641-09 Hymenoptera France
XXVII	1	GMBUE693-14 Hymenoptera Bulgaria
XXVIII	1	LASNA084-08 <i>Lasioglossum villosulum</i> France
XXIX	1	LASNA837-08 <i>Lasioglossum</i> sp. aff. <i>villosulum</i> Israel

in one majority-rule consensus tree (see Fig. 3) with the support values mapped from non-parametric bootstrap calculation using SumTrees ver. 4.3 (Sukumaran & Holder 2017) in DendroPy (Sukumaran & Holder 2010). Bootstrap values $\geq 70\%$ were considered as the threshold for good confidence to tree topologies (Hillis & Bull 1993).

For BI analyses, the TIM and TrN substitution models are not implemented in MrBayes and were replaced by their closest relative model (Huelsenbeck & Rannala 2004), the GTR model. Two parallel runs with four chains of Markov Chain Monte Carlo (MCMC) each were run for five million generations and every 1000th generation was sampled. The BI analysis was stopped after checking convergence between both runs using the average standard deviation of split frequencies and the first 25% of the trees were discarded ('burn-in'). Posterior probabilities were then estimated and a majority-rule consensus tree was constructed (see Fig. 4). Posterior probabilities ≥ 0.95 were considered as the threshold for good confidence to tree topologies (Wilcox *et al.* 2002). All phylogenetic trees (ML and BI) were drawn using FigTree ver. 1.4.3 (Rambaut 2017) and the document (.svg) was modified with Inkscape ver. 0.92.2.

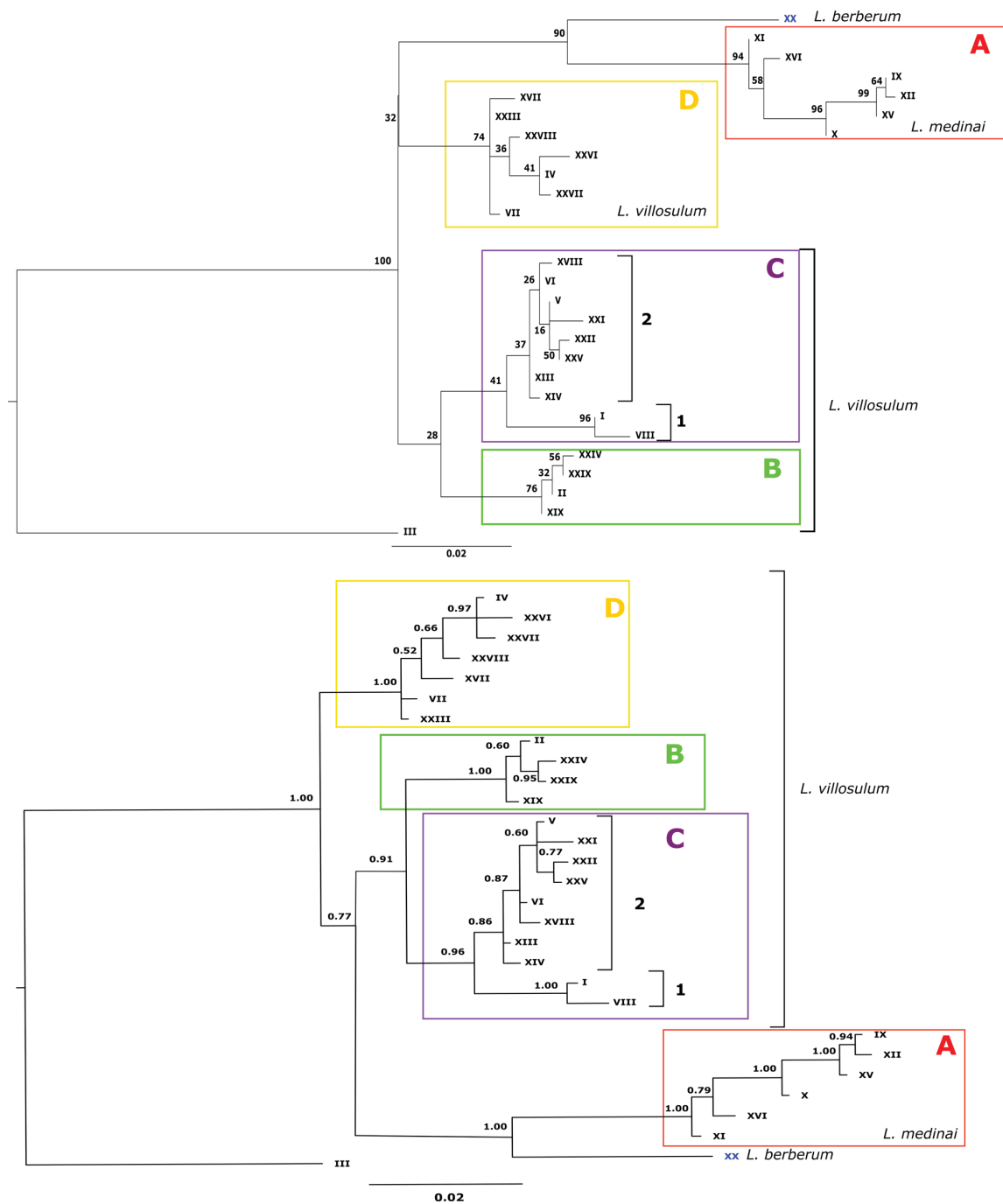

Fig. 3. Trees constructed using maximum likelihood (above) and Bayesian inference (below) and based on 29 haplotype sequences (658bp) of the cytochrome oxidase *c* subunit I gene of specimens currently identified as *Lasioglossum villosulum* (Kirby, 1802), *Lasioglossum medinai* (Vachal, 1895) and one as *Lasioglossum berberum* (Benoist, 1941). Each label corresponds to one roman letter which encompasses all sequences from a haplotype (for more details see Table 3). A, *Lasioglossum medinai*; B–D: *Lasioglossum villosulum*. Label highlighted in blue corresponds to *L. berberum*. This phylogenetic tree is rooted using *Lasioglossum bluethgeni* Ebmer, 1971 as outgroup (label III, voucher AP222). Bootstrap support (%) and posterior probabilities are given at nodes.

Species delineation analyses

For species delineation analysis, we generated an ultrametric tree using the BEAST2 ver. 2.5.2 environment (Bouckaert *et al.* 2014). Following Michonneau (2016), coalescent model with constant population size combined with constant clock was used as prior for expressing the expected topology of the tree. We followed GTR model as in MrBayes analysis with Gamma Category Count of four to capture most of the rate variation. We set-up MCMC length to five million of generation. For the run, we checked the posterior probabilities as well as the effective sample size (> 200) with Tracer ver. 1.7.1 program (Rambaut *et al.* 2018). Then, we summarized Bayesian information into phylogenetic tree via TreeAnnotator ver. 2.5.2. (included in BEAST environment) program with a burn-in of 10%.

As recommended by Tang *et al.* (2014), we conducted Generalized Mixed Yule Coalescent (GMYC, Fujisawa & Barraclough 2013; Pons *et al.* 2006) and Bayesian Poisson Tree Process (bPTP) analyses (Zhang *et al.* 2017). The ultrametric tree was used as input for the GMYC analysis, which was performed with single threshold approach (Fujisawa & Barraclough 2013) on RStudio ver. 3.5.1 (2018) using *ape*, *rnc1* (Michonneau *et al.* 2018) and *splits* (Ezard *et al.* 2017) packages. The bPTP analysis, was

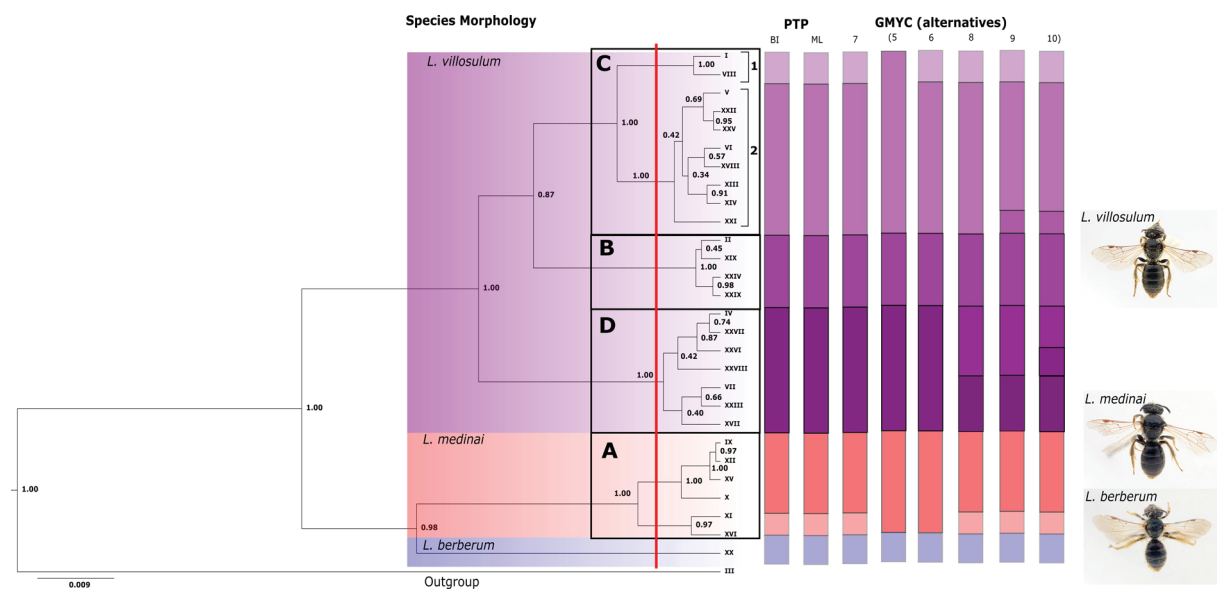

Fig. 4. Ultrametric tree constructed using Bayesian inference and based on 29 haplotype sequences (658bp) of the cytochrome oxidase *c* subunit I gene of specimens currently identified as *Lasioglossum villosulum* (Kirby, 1802), *Lasioglossum medinai* (Vachal, 1895) and one as *Lasioglossum berberum* (Benoist, 1941). Each label corresponds to one roman letter which encompasses all sequence from a haplotype (for more details see Table 3). A–D: *Lasioglossum medinai*; B–D: three supported clusters (a fourth cluster could be defined in C) within *Lasioglossum villosulum*. This phylogenetic tree is rooted using *Lasioglossum bluethgeni* Ebmer, 1971 as outgroup (label III, voucher AP222). Posterior probabilities are given at nodes. The three colour gradients on the tree correspond to morphological delineation. Results of the species delimitations analyses are represented on the right side of the figure: the Bayesian Poisson Tree Process (bPTP) analyses based on the trees obtained using Bayesian inference (BI) or maximum likelihood (ML); The Generalized Mixed Yule Coalescent (GMYC) analysis resulting in seven candidate species (using the single threshold represented as a red line on the tree) and five alternative scenarios. Numbers at the top of the columns corresponds to the number of candidate species in the GMYC analysis.

performed on the Web Server (<https://species.h-its.org/ptp/>) of The Exelixis Lab with default parameters and using the ultrametric tree as input.

Results

DNA analyses

Our COI dataset comprised 29 unique haplotypes: 1 corresponding to the outgroup (Fig. 3; label III or *L. bluethgeni*), 1 to *L. berberum* (Fig. 3; label XX), 6 to *L. medinai* (Fig. 3A) and 21 to *L. villosulum* (Fig. 3B, C (1–2) and D). All specimens identified as *L. medinai* and sequenced here cluster together in all phylogenetic analyses, with a bootstrap support of 94% in the ML analysis, and a posterior probability of one in the Bayesian inferences (ultrametric and non ultrametric trees) (clade A in Fig. 3 and Fig. 4). The haplotype identified as *Lasioglossum berberum* (haplotype XX highlighted in blue in Fig. 3) appears as a sister-species of *L. medinai* according to all tree reconstructions. All remaining haplotypes identified as *L. villosulum* were found on other branches (Fig. 3B–D and Fig. 4). They formed a clade in the ultrametric tree obtained by BI (Fig. 4) but their relationships were not resolved in the other phylogenetic analyses (Fig. 3). They clustered in at least three divergent groups with posterior probabilities of 0.96–1.00 in the BI analysis. Only two of these clusters were supported (with bootstrap values of 74–76%) in the ML analysis (Fig. 3).

The GMYC analysis estimated seven candidate species (six clusters of haplotypes and the single haplotype of *L. berberum* (haplotype XX in Fig. 4) with a minimum of five and a maximum of 10 candidates species. The same seven candidate species were suggested using the bPTP approach (Fig. 4). In the species delimitation suggesting the lowest number of species (five candidates species), *L. medinai*, *L. berberum* and three clades of *L. villosulum* (corresponding to the clades B–D in the phylogenetic trees) were considered as possible distinct species. In the species delimitations proposing more than five species, *L. medinai* and *L. villosulum* were further split in two to seven candidate species (Fig. 4). We did not find any diagnostic morphological characters enabling the distinction among these candidate species. They are also not distributed according to geographical patterns.

Intraspecific genetic divergences within and among clusters B, C and D of *L. villosulum* (ranging from 0% to 4.8%) are comparable to those within the cluster of *L. medinai* (ranging from 0% to 3.2%). In the NJ tree, all specimens identified as *L. medinai* and sequenced here cluster together with maximum bootstrap support (Fig. S1A). In all analyses, the cluster of *L. medinai* also includes seven sequences from GenBank, two identified as *L. villosulum* in the study of Schmidt *et al.* (2015) (accession numbers KJ838409 and KJ837678; highlighted in red colour in Fig. S1, [available in Supplementary material](#)) and five records of specimens that were not identified to the species level.

Systematics

Class Insecta Linnaeus, 1758
Order Hymenoptera Linné, 1758
Family Halictidae Thomson, 1869
Tribe Halictini Thomson, 1869
Genus *Lasioglossum* Curtis, 1833

Lasioglossum villosulum (Kirby, 1802)

This species was classified in the subgenus *Evyllaesus* Robertson, 1902 by Ebmer (1988) and more recently placed in the subgenus *Hemihalictus* Cockerell, 1897 by Gibbs *et al.* (2013).

Subspecies *villosulum*

Synonymy

- Melitta villosula* Kirby, 1802: 62. Type: 1 ♂, England (NHMUK013380582), male lectotype designated by Ebmer 1988: 649. Examined by DGN (Fig. 6).
- Melitta punctulata* Kirby, 1802: 66. Type: 1 ♀, England, [Kent] Barham (NHMUK013380583). Syn. by Dalla Torre 1896: 90. The holotype examined by DGN (Fig. 7), is a typical *L. villosulum villosulum*, small size, large sparse punctures, etc. It does not agree with the pseudocryptic species.
- Halictus hirtellus* Schenck, 1869: 311. Type: 1 ♀, Germany, Elberfeld near Letmathe an der Lenne, leg. Cornelius (SMF), lectotype designated by Ebmer 1975: 244; syn. by Blüthgen 1920: 278, 1930: 743. Examined by AP (Fig. 5).
- Halictus pauperatulellus* Strand, 1909: 44. Holotype: ♂, Algeria, Blidah-Médéah, Jul.–Aug. 1884, leg. Quedenfeldt (MNHUB). Syn. by Blüthgen 1922: 318. Examined by AP (Fig. 8).
- Halictus barkensis* Blüthgen, 1930: 224. Types: “1 ♀, 1 ♂”, Libya, Bengasi, 20 Aug. 1924, coll. Blüthgen (MNHUB), not examined.
- Halictus villosulus perlautus* Cockerell, 1938a: 82. Holotype: 1 ♂, Morocco, Asni, Aug. 1930, leg. Cockerell (NHMUK013380275). Syn. by Warncke 1973: 290. Examined by DGN.
- Halictus rufotegularis* Cockerell, 1938b: 7. Holotype: 1 ♀, Morocco, Ifrane, 27 Aug. 1930, leg. Alice Mackie (AMNH). Syn. by Ebmer 1976: 253 (21 March) and Warncke 1976: 95 (15 October). Examined by AP (Fig. 9).
- Halictus villiersi* Benoist, 1941: 80. Holotype: ♀, Morocco, Djebel Tachdirt, 2500 m, 15–31 Aug. (MNH). Syn. by Warncke 1973: 290. Examined by AP (Fig. 10).

Remarks

Halictus hirtellus

The type of *Halictus hirtellus* Schenck, 1869, was examined by Blüthgen (1920: 278). Blüthgen (1930: 743) also mentions our pseudocryptic species as a form needing more research and he specifies that it is not *Halictus hirtellus* (“die nicht etwa *hirtellus* Schck ist”). Ebmer (1975) designated a lectotype from Letmathe an der Lenne (51°22' N, 7°36' E), a locality in Germany, that is out of the distribution of the new sub-Mediterranean pseudocryptic species *L. medinai* (the specimen from Germany in the cluster of *L. medinai* comes from a locality further south: Baden-Württemberg, Müllheim, 47°49' N, 7°37' E).



Fig. 5. *Halictus hirtellus* Schenck, 1869, lectotype, ♀.

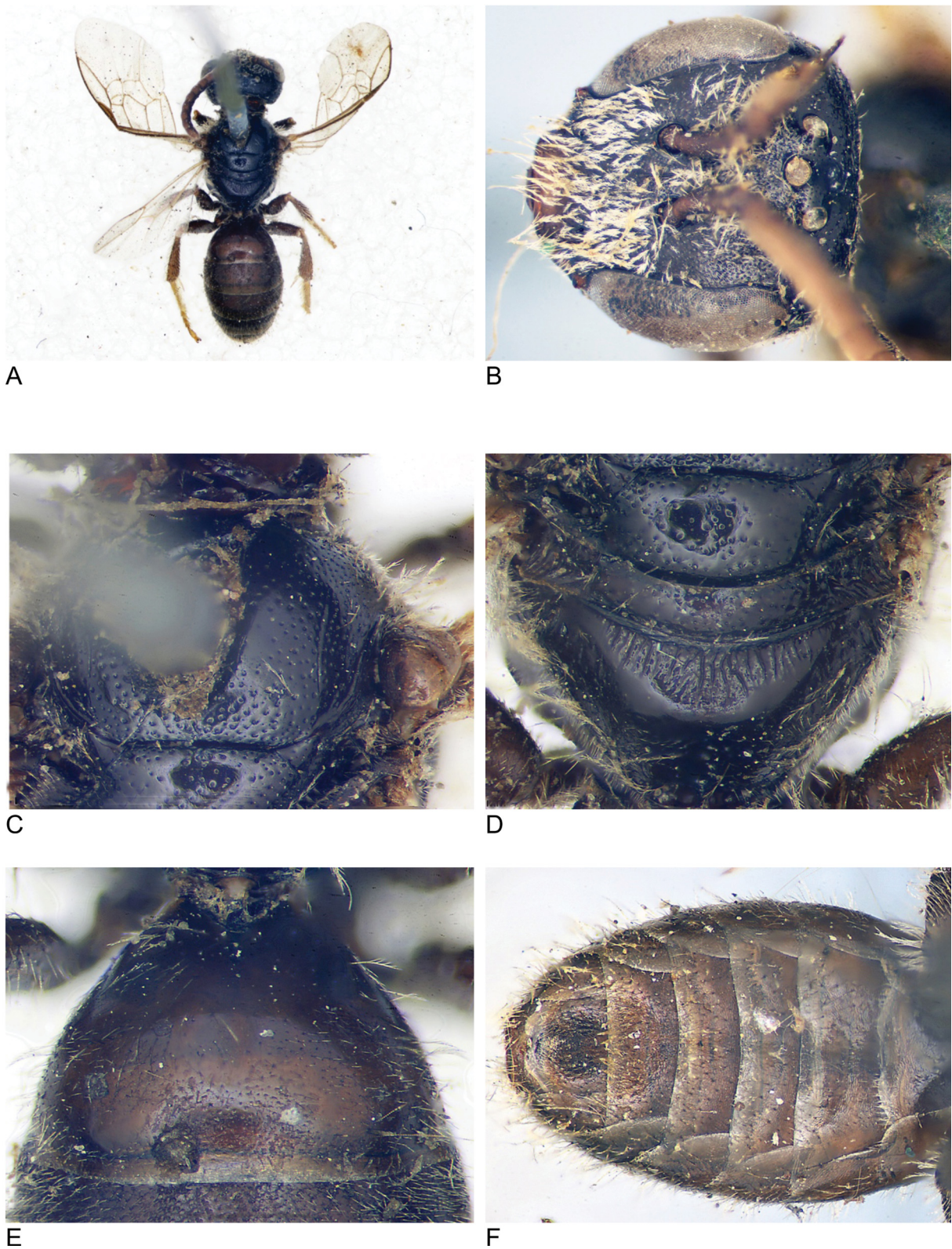

Fig. 6. *Melitta villosula* Kirby, 1802, lectotype, ♂ (= *Lasioglossum villosulum*). A. Habitus. B. Head. C. Scutum. D. Propodeum. E. First tergum. F. Sterna.

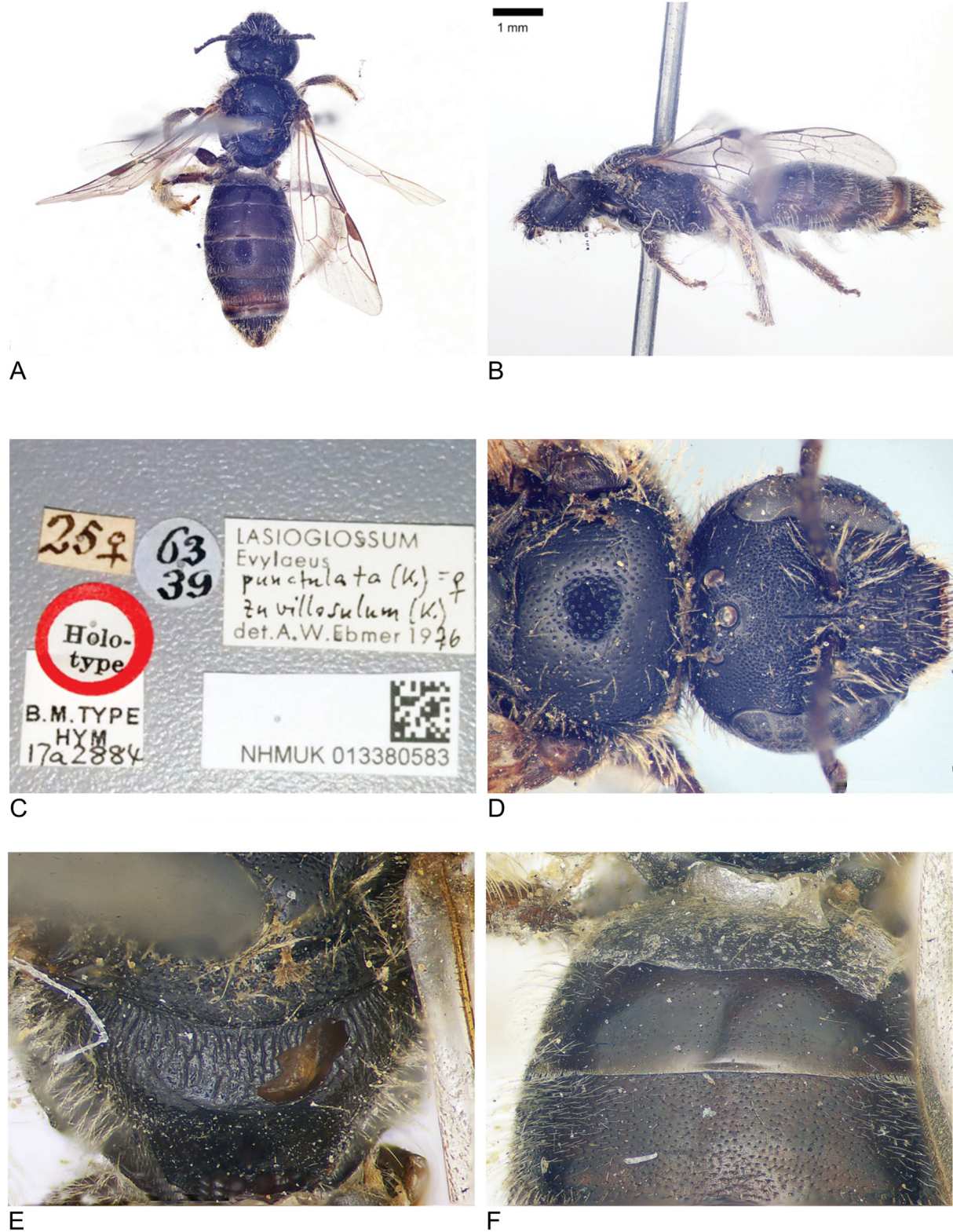

Fig. 7. *Melitta punctulata* Kirby, 1802, holotype, ♀. A. Habitus, dorsal view. B. Habitus, lateral view. C. Labels. D. Scutum and head. E. Propodeum. F. Tergum 1 and 2 (metasoma glued).

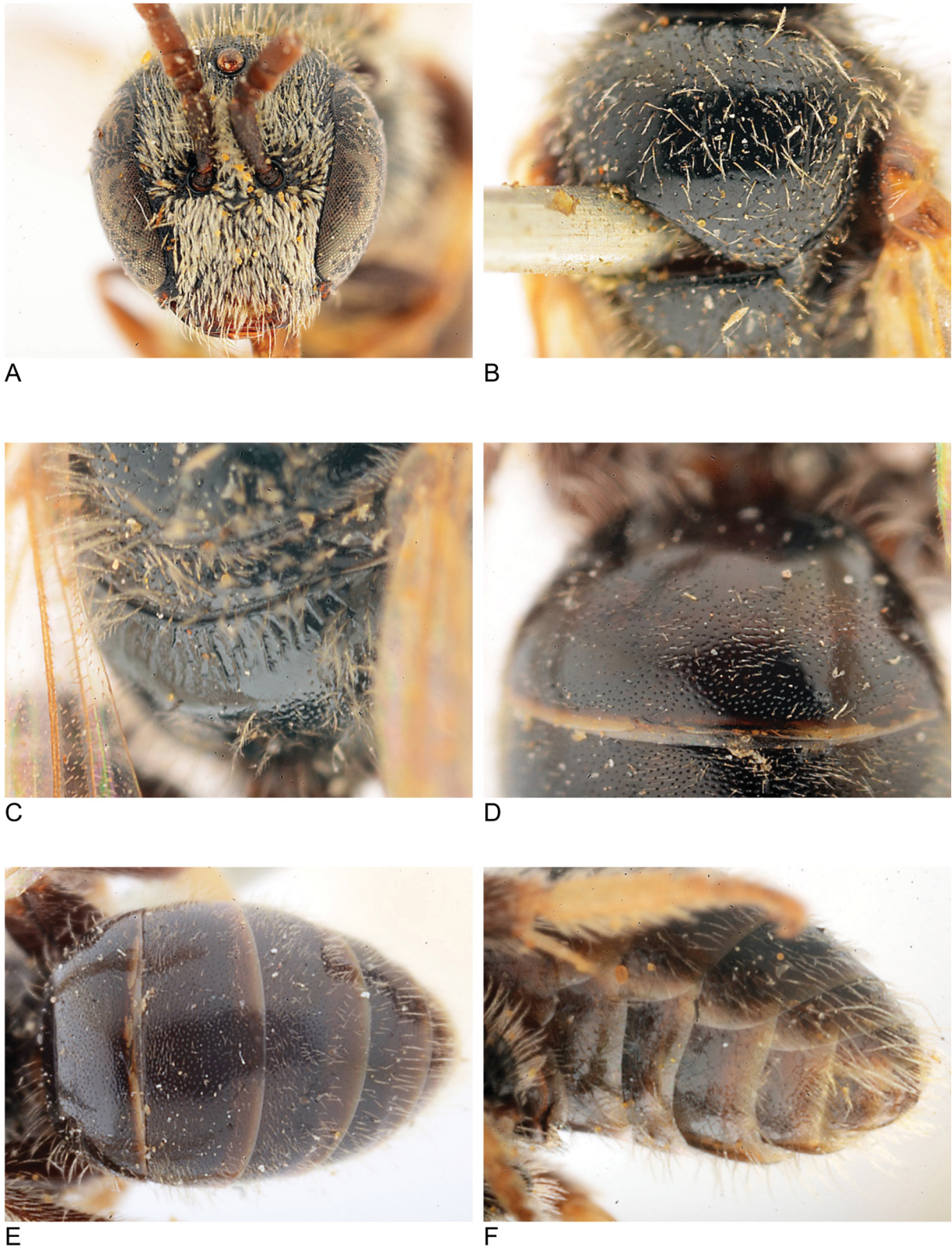

Fig. 8. *Halictus pauperatulellus* Strand, 1909, holotype, ♂. **A.** Head. **B.** Scutum. **C.** Propodeum. **D.** First tergum. **E.** Metasoma, dorsal view. **F** Metasoma, ventral view.

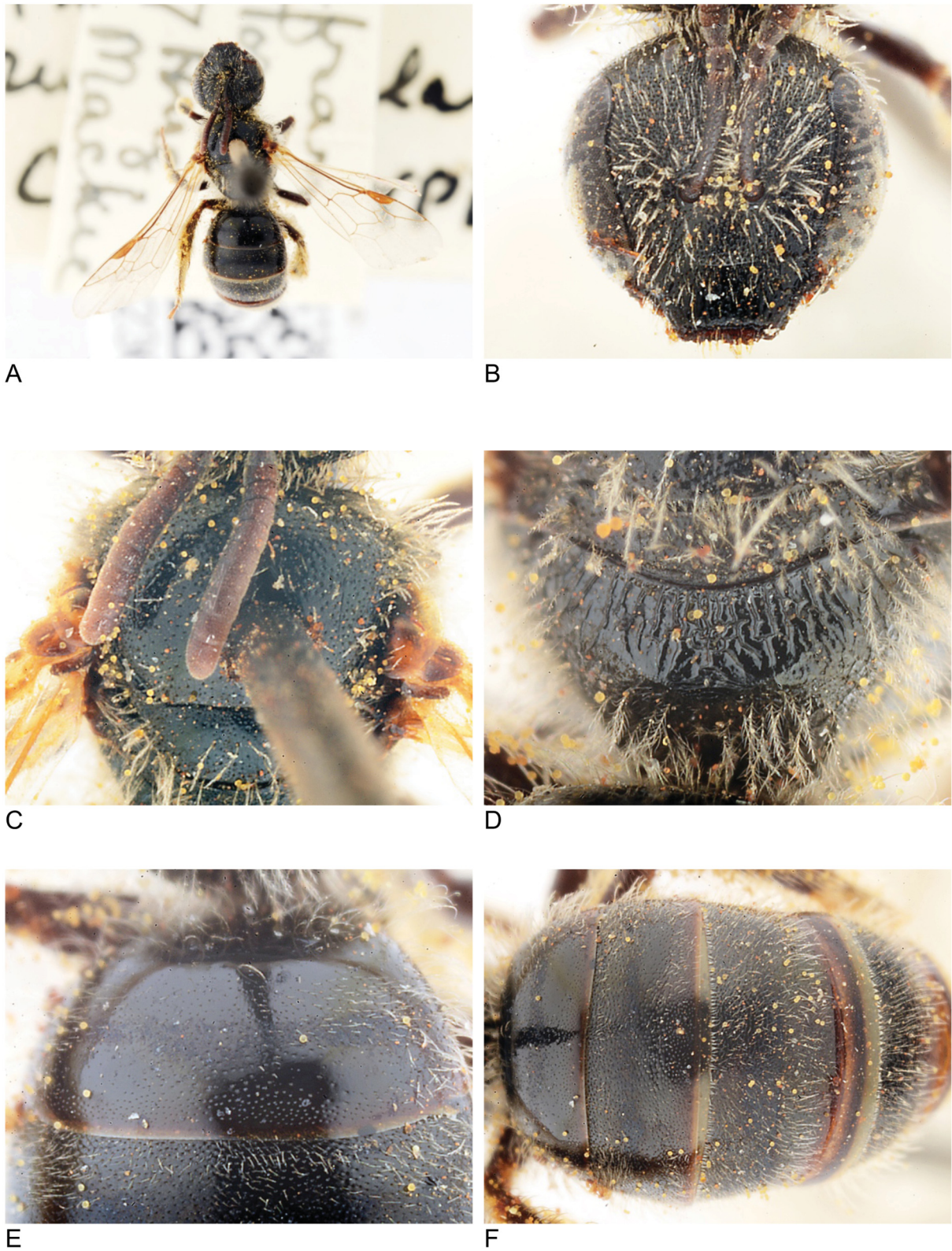

Fig. 9. *Halictus rufotegularis* Cockerell, 1938, holotype, ♀. **A.** Habitus, dorsal view. **B.** Head. **C.** Scutum. **D.** Propodeum. **E.** First tergum. **F.** Metasoma.

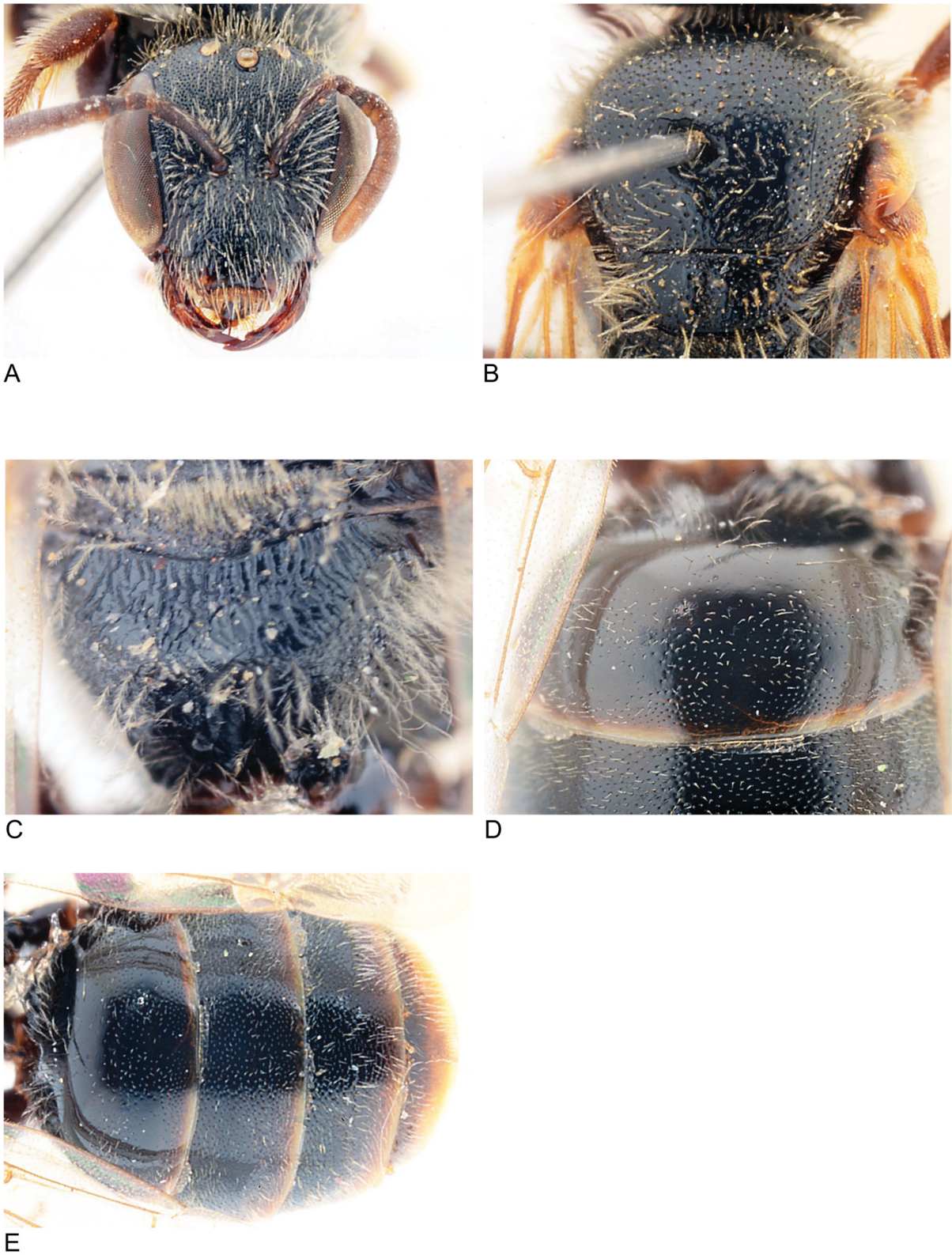

Fig. 10. *Halictus villiersi* Benoist, 1941, holotype, ♀. **A.** Head. **B.** Scutum. **C.** Propodeum. **D.** First tergum. **E.** Metasoma.

Halictus barkensis

Blüthgen described this species as close to *L. villosulum*, but with a longer head. Ebmer (1974: 188; 1976: 253) considered *L. barkense* as a valid species occurring in Morocco (Grand Atlas), Libya, Israel and Turkey, but Warncke (1976: 94), Ebmer (1988: 649) and Pesenko (2007a: 41) considered it a synonym of *L. villosulum*.

Halictus villiersi

The type of *H. villiersi* is relatively small (6 mm), the punctation of the scutum is relatively dense and the propodeum is relatively well wrinkled. Ebmer (1974: 188; 1976: 253) considered *L. villiersi* as a synonym of *L. barkense* (Blüthgen, 1930) but Ebmer (1988: 649) reassessed it as a synonym of *L. villosulum*.

Distribution

Distribution (the asterisk * means that identification of specimens from that country has been confirmed in the current study): This subspecies is distributed throughout the western Palaearctic. Described from the United Kingdom, it is known from the Azores* (Weismann *et al.* 2017: 82), Madeira (Fellendorf *et al.* 1999: 4), Canary Islands (Warncke 1975b: 205), Spain* (including the Balearics*) (Ortiz-Sanchez & Pauly 2017: 40), France* (including Corsica) (Pauly & Belval 2017: 27), Belgium*, The Netherlands*, Luxemburg*, Germany*, Denmark (Rasmussen *et al.* 2016: 47), Norway*, Sweden (Svensson *et al.* 1990: 50), Finland* (north to 64° N), Ireland*, Switzerland (Amiet *et al.* 2001: 150), Italy* (including Sardinia), Austria (Ebmer 1988: 649), Czech Republic and Slovakia (Pridal 2004: 40), Poland (Pesenko *et al.* 2000: 291), Slovenia (Gogala 1999: 19), Serbia*, Croatia*, Romania (Goaga 2003: 193), Bulgaria*, Greece* (including Crete*), Ukraine, Turkey (Warncke 1975a: 91), Israel* (Bytinsky-Salz & Ebmer 1974: 188), Russia (Levchenko 2015: 17), Udmurtia (Pesenko 2007b: 113), Iran (Ebmer 1978c: 76), Afghanistan (Ebmer 1974: 200), India (Himashal Pradesh; Ebmer 2004: 131), Nepal (Ebmer 2004: 131), Morocco* (Ebmer, 1976: 253), Algeria*, Tunisia*, Libya (Blüthgen 1930: 224), Egypt (Blüthgen 1933: 19), Yemen* (Sanaa, Jebel Jaïf). The subspecies occurs also in North America where it has been barcoded from Canada (British Columbia*) and USA (Washington State*) (Gibbs, pers. comm.).

Subspecies *trichopse* (Strand, 1914)

Synonymy (following Ebmer 1988: 649)

Halictus trichopsis Strand 1914: 156. Holotype: ♂, Taiwan, Taihorin, Jan. 1910 (SDEI). Not examined.

Halictus melanomitratus Strand 1914: 156. Holotype: ♀, Taiwan, Taihorin, 7 Nov. 1910 (SDEI). Syn. by Blüthgen 1923: 241. Not examined.

Halictus melanomitratus var. *mitratolus* Strand 1914: 158. Holotype: ♀, Taiwan, Taihorin, Par. 1910 (SDEI). Syn. by Blüthgen 1923: 241. Not examined.

Halictus villosulopsis Blüthgen 1926: 540. Syntypes: 3 ♀♀, Assam, Shillong, May 1903, leg. Turner (NHMUK013380276). Syn. by Ebmer 1978a: 207. Examined by DGN.

Halictus pahanganus Blüthgen 1928: 374. Holotype: ♂, Malaysia, Lubok Tamang, cleared Hill, 4000 ft, Pahang, Federated Malay States, 10 Jun. 1923 (NHMUK013380277). Syn. by Ebmer 1978a: 207. Examined by DGN.

Distribution

This subspecies is distributed from East Himalaya, China (Ebmer 1978a: 207; 2006: 569), Mongolia (Ebmer 1982: 219; 2005: 378), Japan (Hokkaido: Usui *et al.* 1976: 228; Izu: Takahashi & Sakagami 1993: 271, 275; Honshu: Haneda 1990: 8; Okinawa: Azuma & Kinjo 1987: 314), North Korea (Ebmer 1978b: 315), South Korea (Murao 2017), south of Russian Far East (Primorsk Terr.: Ebmer 1996: 285, 2006: 569; Amur Prov.: Pesenko 2007b: 113), Taiwan and south to Malaysia (Fig. 11). It is not the



Fig. 11. Geographical distribution of *Lasioglossum villosulum trichopse* (Strand, 1914).



Fig. 12. Heads. **A.** *Lasioglossum villosulum villosulum* (Kirby, 1802), ♀ (France, Allier). **B.** *L. medinai*, ♀ (France, Vaucluse). **C.** *L. villosulum trichopse* (Strand, 1914), ♀ (Taiwan). **D.** *Idem*, ♂.

purpose of this paper to discuss the status and diagnosis of this subspecies, as little material is available for examination and no fresh material was available for DNA study. The subspecies is distinguished from the subspecies *villosulum* mainly by shorter and more rounded head and broader eyes. We have examined and photographed the heads of old specimens from the typical locality in Taiwan and preserved in the MNHUB and compared them with the heads of *L. villosulum villosulum* and *L. medinai* (Fig. 12). The punctuation and genitalia of males are similar to those of *L. villosulum*.

Subspecies *arabicum* Ebmer, 2008

Lasioglossum (Evylaeus) villosulum arabicum Ebmer, 2008: 560. Holotype: ♀, UAE, Sharjah x Khor Kalba, 7–14 Jun. 2006, light trap, leg. A.V. Harten 6681 (SDEI). Examined by AP.

Distribution

This subspecies inhabits the Arabian Peninsula (Oman, UAE) and is distinguished mainly by red terga (Figs 13–14). Also conspicuous are the zones of snow white, felted, adpressed pubescence on the face, particularly on frontal area and pronotum, and white, felted, upstanding hairs on the mesopleura, particularly the front as well as the posterior propodeal surface and the lateral fields above. This pubescence marks the subspecies as a desert form (Ebmer 2008: 560; Dathe 2009: 385). Specimens from Oman and UAE have red terga, whereas those from Yemen, identified as *L. villosulum* by Ebmer (D. Notton, unpublished new record), have dark black terga. Maybe there is more taxonomic complexity here, but it is outside the scope of the current project to further examine this. It may correlate with topography and climate since Oman and UAE are generally lower altitude (hotter) and Yemen is generally higher altitude (cooler).

Lasioglossum medinai (Vachal, 1895)

Halictus medinai Vachal, 1895: 148. Holotype: ♂, Spain, Sevilla, “col. Medina” (MCSN), examined. Blüthgen 1923: 239 (syn. of *H. villosulus*). Examined by AP.

New diagnosis

Morphological examination of the type of *Halictus medinai* confirms that this large specimen belongs to the cryptic species. Its size is 7 mm (Fig. 2C–D), the punctuation of the scutum is denser than in *L. villosulum*. Head, punctuation of the scutum, sculpture of propodeum and punctuation of terga of the male holotype are illustrated (Fig. 15).

Morphological examination of the females makes it possible to note immediately, in addition to a larger body size (7 mm), the denser punctuation of the scutum (Fig. 16) as well as the stronger wrinkles of the propodeum, which reach the posterior edge (Fig. 17). In most cases, we can verify the identification using two more subtle characters:

- (1) the punctuation of the tergum 1 is much more superficial in the middle and on the apical margin, absent in the middle of the apical margin, whereas in *L. villosulum* the punctuation of the tergum 1 is deeper and the apical margin is punctuated even in the middle (Fig. 18).
- (2) a small unpunctuated area in front of the larger anterior ocelli, more extended than in *L. villosulum*, and punctuation around this area finer (Fig. 19).

Morphological examination of a single male of *L. medinai* obtained by breeding and from Uchaux confirms that males of this species also have denser punctuation on the scutum. The genitalia of several large males with denser punctuation of the scutum and collected at the same time as females of *L. medinai* show only very subtle differences which may be characteristic (Fig. 20):

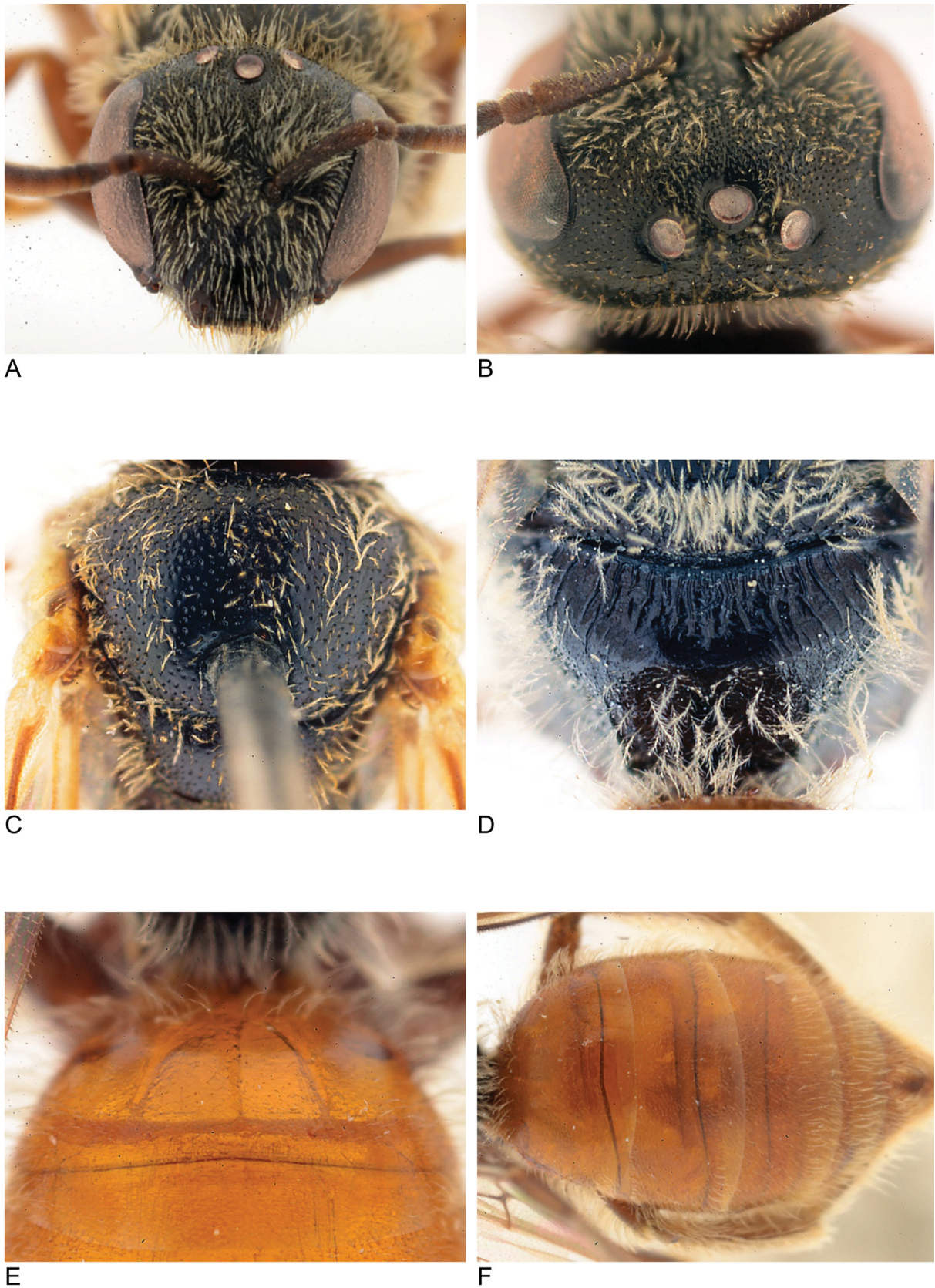

Fig. 13. *Lasioglossum villosulum arabicum* Ebmer, 2008, ♀ (UAE). A. Head. B. Punctuation around ocellus. C. Scutum. D. Propodeum. E. First tergum. F. Metasoma.



Fig. 14. *Lasioglossum villosulum arabicum* Ebmer, 2008, ♂ (UAE). **A.** Head. **B.** Scutum. **C.** Propodeum. **D.** First tergum. **E.** Metasoma.

– *L. medinai*: reflexed gonostylus lobe with apex blunt (Fig. 20Cb), outer hind corner more produced (Fig. 20Ca); gonostylus in line with axis of gonocoxite (Fig. 20Cc).

– *L. villosulum*: reflexed gonostylus lobe with apex more tapered, outer hind corner less produced; gonostylus directed inwards relative to axis of gonocoxite.

Also, in *L. medinai* the bristles of the last sterna form a slightly thicker fringe (Fig. 21).

Material examined

The following specimens of *Lasioglossum medinai* were identified by morphology (the asterisk * indicates the specimens selected for barcoding); countries are mentioned from west to east and from north to south:

SPAIN – **Cadiz** • 2 ♀♀*; Jerez de la Frontera, 29SQA541660; 40 m; 29 Mar. 2009; J. Ortiz-Sanchez leg. – **Segovia** • 1 ♀*; Rio Millanillos, Madrona; 40°54' N, 4°09' W; 930 m; 9 Jun. 2012; J. Ortiz-Sanchez leg. – **Albacete** • 1 ♀; Caserio zapateros, Sa Alcaraz, 30SWH44468; 1150 m; 23 Apr. 2005, F.J. Ortiz-Sanchez leg. – **Cordoba** • 3 ♀♀; Fuente Obejuna, 30STH7940; 600 m; 26 Apr. 2009; J. Ortiz-Sanchez leg. – **Badajoz** • 1 ♀; Badajoz, 29SPD7209; 200 m; 25 Apr. 2009; J. Ortiz-Sanchez leg.

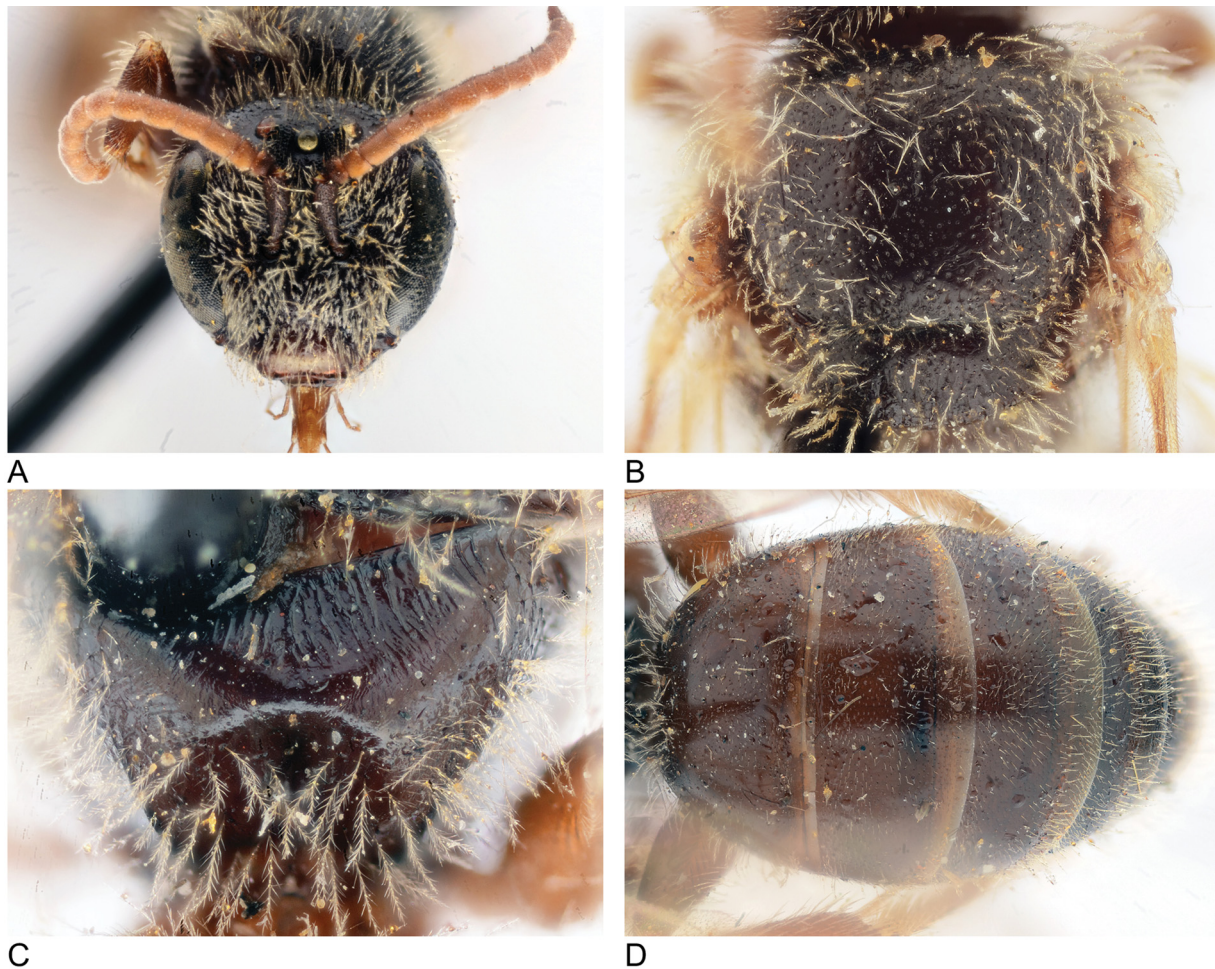
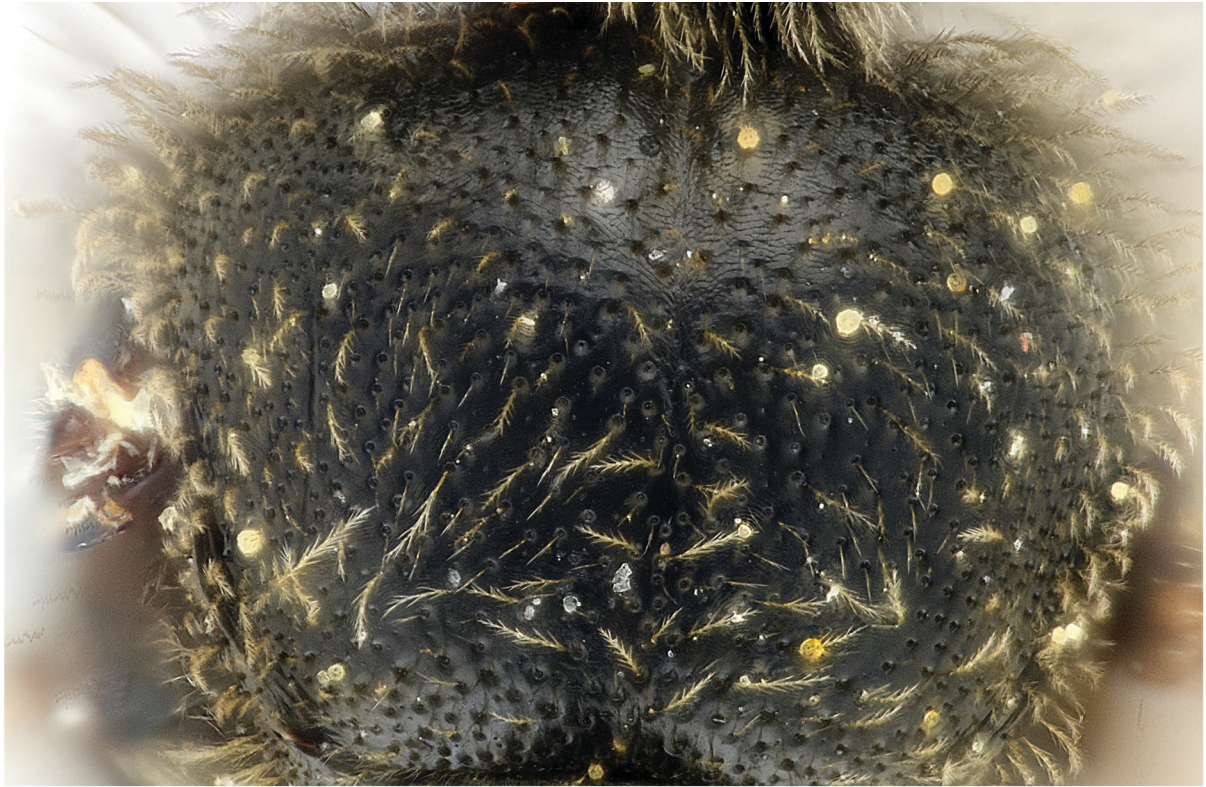

Fig. 15. *Lasioglossum medinai* (Vachal, 1895), holotype, ♂. **A.** Head. **B.** Scutum. **C.** Propodeum. **D.** Metasoma.



A



B

Fig. 16. Punctuation of the scutum of females. **A.** *Lasioglossum medinai* (Vachal, 1895) (France: Uchaux). **B.** *L. villosulum* (Kirby, 1802) (Belgium: Bruges).



A



B

Fig. 17. Propodeum sculpture of females. **A.** *Lasioglossum medinai* (Vachal, 1895) (France: Uchaux). **B.** *L. villosulum* (Kirby, 1802).



A



B

Fig. 18. Punctuation of the first tergum of females. **A.** *Lasioglossum medinai* (Vachal, 1895) (France: Uchaux). **B.** *L. villosulum* (Kirby, 1802) (France: Visan).



A



B

Fig. 19. Punctuation in front of the medial ocellus of females. **A.** *Lasioglossum medinai* (Vachal, 1895) (France: Uchaux). **B.** *L. villosulum* (Kirby, 1802) (Luxembourg: Stadtbredimus).

FRANCE – **Alpes-de-Haute Provence** • 1 ♀; Manosque S of 4.2 km; G. Carré leg.; INRA • 2 ♀♀; 27 Jul. 2005, 4 Aug. 2005; G. Carré leg.; INRA. – **Aude** • 1 ♀*; Arzens, Bellevue; 43°12' N, 2°13' E; 10 May 2014; D. Genoud leg. et coll. • 1 ♀*; Saint-Marcel-sur-Aude, Le Four à Chau; 17 Apr. 2014; D. Genoud leg. et coll. • 1 ♀; Pennautier; 11 Apr. 2015; on *Brassica napus*; O. Rollin leg.; INRA. – **Charente Maritime** • 1 ♀*; Saintes; 45°45' N, 39°07' W, 20 Aug. 2012; N. Sérès leg. – **Drome** • 1 ♀*; Saint-Gervais-sur-Roubion; 44°34' N, 4°53' E; 31 Jul. 2007; G. De Prémourel leg.; from crop of *Helianthus annuus*; INRA • 1 ♀; Marsanne; 28 Jul. 2007; on *Helianthus annuus*; INRA. – **Gard** • 1 ♀; Etang du Ponant; 22 Apr. 1980; GABT. – **Eure** • 1 ♀; Falaise-Giverny; 49°04' N, 1°33' E; 18 May 2017; N. de Manincor leg.; n°FAL-1302. – **Gironde** • 1 ♀*; Lacanau, Cousseau; 5 May 2013; S. Labatut leg. (D. Genoud coll.). – **Loir and Cher** • 1 ♀; Selommes; 19 Apr. 2007 • 1 ♀; 25 Apr. 2007 • 1 ♀; 25 Apr. 2007; NHMUK 013380274 • 1 ♀; 29 Apr. 2007; RBINS • 1 ♀; 30 Apr. 2007; R. Chifflet leg.; INRA. – **Lot** • 1 ♀*; Le Montat; 44°22' N, 1°25' E; 24 May 2012; P. Christophe leg. – **Maine and Loire** • 1 ♀*; Cléré-sur-layon, La Pagerie, XT9518; 25 Apr. 2013; O. Durand leg. – **Pyrénées Orientales** • 2 ♀♀; Perpignan; 10 Apr. 1970; A. Pauly leg.; RBINS • 2 ♀♀; Canet; Apr. 1893; NHMUK 013380289, 013380290. – **Rhône** • 1 ♀*; Lyon; 45°46' N, 4°47' E; 20 Jun. 2011; L. Motino leg.; INRA • 1 ♀; Lyon; 16 Apr. 2013; INRA • 1 ♀; Villeurbanne; 15 Sep. 2010; L. Neu leg.; INRA • 1 ♀; Crépieux; 19 Apr. 2011; L. Fortel leg.; INRA • 1 ♀; Meyzieu; 29 May 2010; L. Neu leg.; INRA. – **Vaucluse** • 14 ♀♀; Uchaux; 18 Apr. 1992; L. Plateaux and C. Plateaux-Quénu leg. et coll. • 1 ♀; Bollène; 22 Apr. 1979; GABT • 1 ♀*; Cucuron, La Rasparine; 43°45' N, 5°27' E; 6 Aug. 2005; G. Carré leg.; INRA • 2 ♀♀*; La Tour d'Aigues, St Victor; 2 Aug. 2005; G. Carré leg.; INRA • 3 ♀♀*; 10 Aug. 2005; G. Carré leg.; INRA • 1 ♀; La Motte d'Aigue, La Pavine; 16 Jul. 2004; R. Chifflet leg.; INRA • 1 ♂, 12 ♀♀; 30 Jul. 2004; same collection data as for preceding; INRA • 1 ♂; same collection data as for preceding; RBINS • 6 ♀♀; 6 Aug. 2004; same collection data as for preceding; INRA • 1 ♀; same collection data as for preceding; NHMUK 013380273 • 1 ♂, 2 ♀♀; Uzès, Mas Marsau; 1 Aug. 2005; G. Carré leg.; INRA • 2 ♀♀; same collection data as for preceding; 8 Aug. 2005; INRA • 1 ♀; same collection data as for preceding; 15 Aug. 2005; INRA • 1 ♀; same collection data as for preceding; 22 Aug. 2005; INRA • 2 ♀♀; Saint Jean de Maruejol, Mas Imbert; 1 Aug. 2005; G. Carré leg.; INRA • 2 ♀♀; Cucuron, La Rasparine; 6 Aug. 2005; G. Carré leg.; INRA • 1 ♀; same collection data as for preceding; 16 Aug. 2005; G. Carré leg.; INRA • 1 ♀; Villelaure, Versailles; 6 Aug. 2004; R. Chifflet leg.; INRA • 1 ♂, 6 ♀♀; same collection data as for preceding; 30 Jul. 2004; R. Chifflet leg.; INRA • 1 ♀; same collection data as for preceding; RBINS • 1 ♀; Villelaure, Saint Pierre; 2 Aug. 2005; G. Carré leg.; INRA • 5 ♀♀; Villelaure, St Marc; 30 Jul. 2004; R. Chifflet leg.; INRA • 8 ♀♀; same collection data as for preceding; 6 Aug. 2004; R. Chifflet leg.; INRA • 1 ♀; Velleron, La Mourette; 26 Jul. 2002; B. Vaissière leg.; INRA • 2 ♀♀; Lourmarin, La Haute Prairie; 16 Jul. 2014; R. Chifflet leg.; INRA • 4 ♀♀; same collection data as for preceding; 30 Jul. 2004; R. Chifflet leg.; INRA • 8 ♀♀; same collection data as for preceding; 6 Aug. 2004; R. Chifflet leg.; INRA • 1 ♀; Montfavet, St Maurice; 27 Jul. 2002; on *Lactuca serriola*; B. Vaissière leg.; INRA.

ITALY – **Lazio** • 1 ♀; Gallinaro; 19–20 Jul. 1983; R. Wahis leg.; GABT. – **Campania** • 1 ♀; Caserta; Apr. 1895; NHMUK 013380288. – **Veneto** • 2 ♀♀; Laguna Veneta; 1944; Soika leg.; NHMUK 013380299, 013380300.

AUSTRIA • 1 ♀; Türkenschang, Wien; 1 May 1938; Pittioni leg.; NHMUK 013380297 • 1 ♀; Stammersdorf; 8 May 1946; NHMUK 013380302 • 1 ♀; same collection data as for preceding; 19 May 1946; NHMUK 013380301.

ROMANIA • 1 ♀; Dobrogea, Macin; Montadon leg.; NHMUK 013380292.

GREECE • 1 ♀, 2 ♂♂; Thessalia, Kalambaka, hillside meadow; 14–20 Jul. 1979; Day, Else and Morgan leg.; NHMUK 013380281, 013380762, 013380763 • 1 ♀; Old Lefkas, Lefkas; 25 Apr. 1977; Guichard

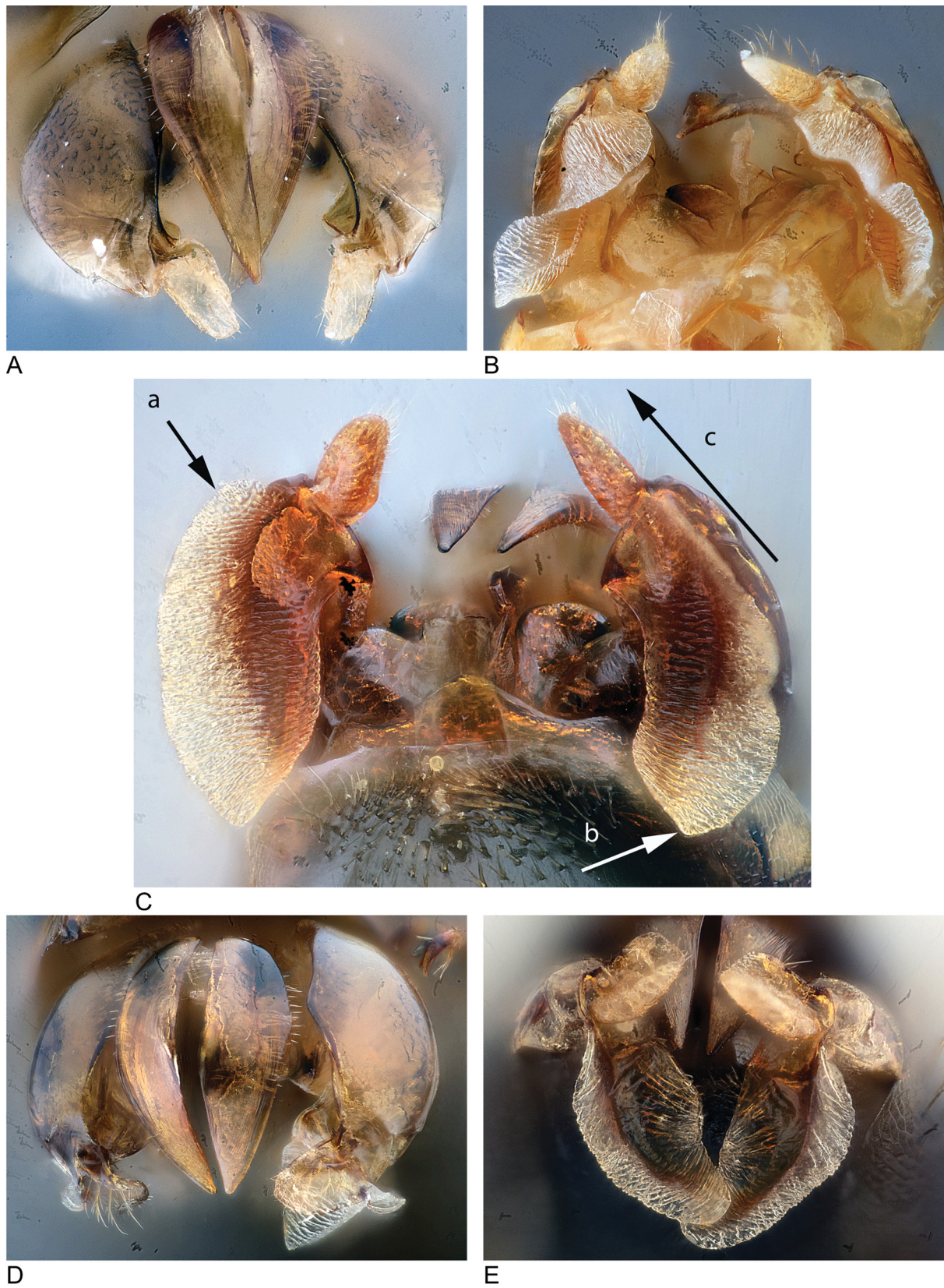

Fig. 20. Male genitalia in dorsal and ventral views. **A–B.** *Lasioglossum medinai* (Vachal, 1895) (France: Alpes de Haute-Provence, Manosque). **C.** *L. medinai* (Greece: Thessalia, Kalambaka) (explanation of arrows in the text). **D–E.** *L. villosulum* (Kirby, 1802) (Belgium).

leg.; NHMUK 013380283 • 1 ♀; Iliia, Olympia; 4 Jul. 1979; Day, Else and Morgan leg.; NHMUK 013380285 • 1 ♂, 1 ♀; Crete, Asprouliani; 35°21' N, 24°17' E; alt. 0–10 m; 25 Jun. 2017; A. Pauly leg.; RBINS.

CYPRUS • 2 ♀♀; Limassol; Feb. 1934; Mavromoustakis leg.; NHMUK 013380293, 013380294 • 1 ♀; Nicosia; 15 Apr. 1971; K. Guichard leg.; NHMUK 013380295 • 1 ♀; Larnaca; 17 Mar. 1971; K. Guichard leg.; NHMUK 013380296.

RUSSIA • 1 ♀; Michailowka [?] = Mikhailovskaya; 3 Oct. 1942; NHMUK 013380303.

ALGERIA • 1 ♀*; Biskra, Tolga; 34°43' N, 5°23' E; 23 Mar. 2011; H. Djouama leg. et coll.

ISRAEL • 1 ♀*; Judean foothills, Mevo Horon; 31°52' N, 35°02' E; 7 Jun. 2011; Y. Mandelik leg.; HJ 80871.

Distribution (Fig. 22)

Lasioglossum medinai is a sub-Mediterranean species, occurring in Spain, France, Italy, Austria, Romania, Greece (including Crete), Turkey, Cyprus and North Africa to Israel. There was no evidence of *L. medinai* in Britain (DGN).

Lasioglossum berberum (Benoist, 1941)

Halictus berberus Benoist, 1941: 81. Holotype: ♂, Morocco, Dj M'Goum, 3200 m, 1–15 Sep. (MNHN). Examined (AP) (Fig. 23).

Remarks

Ebmer (1976: 251; 1988: 649) considers this species as valid, but Pesenko (2007a: 41) following Warncke (1976: 94) mention it as a synonym of *L. villosulum*. This small species of 6 mm length is very close to *L. villosulum*, but is well separated by its barcode. We have examined the type and we can confirm that it differs from *L. villosulum* by the impunctate apical margin of the terga (Fig. 23D), as mentioned by Ebmer (1976: 251).

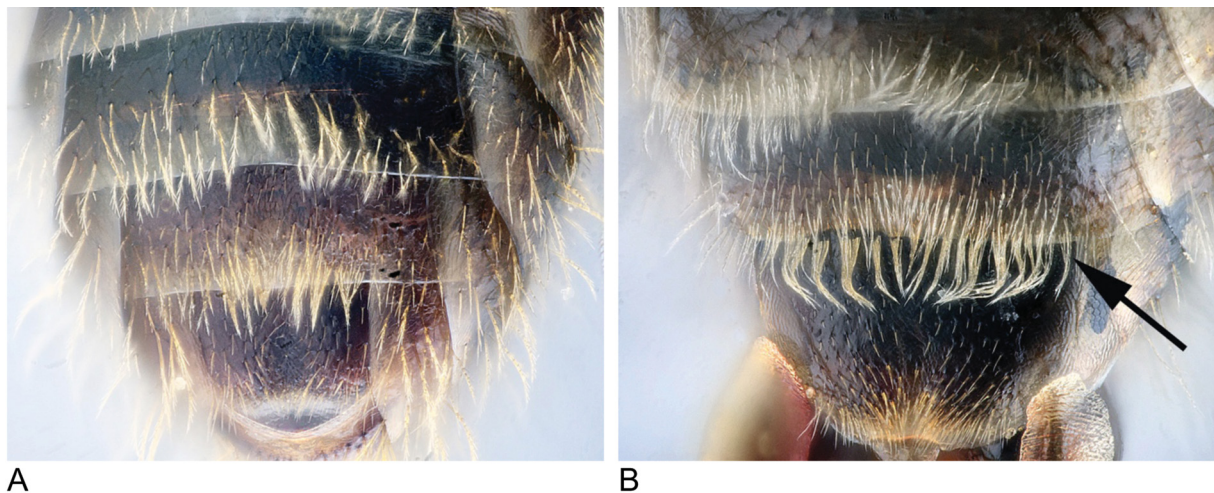
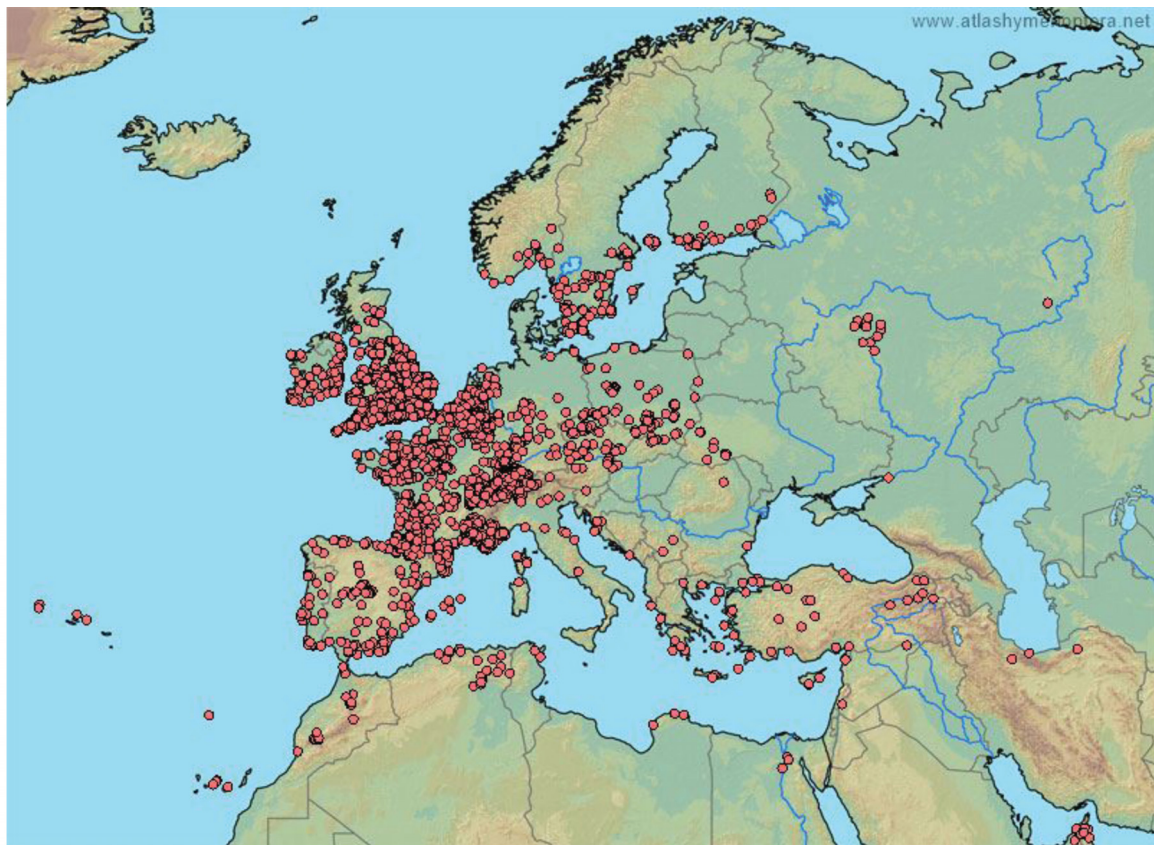
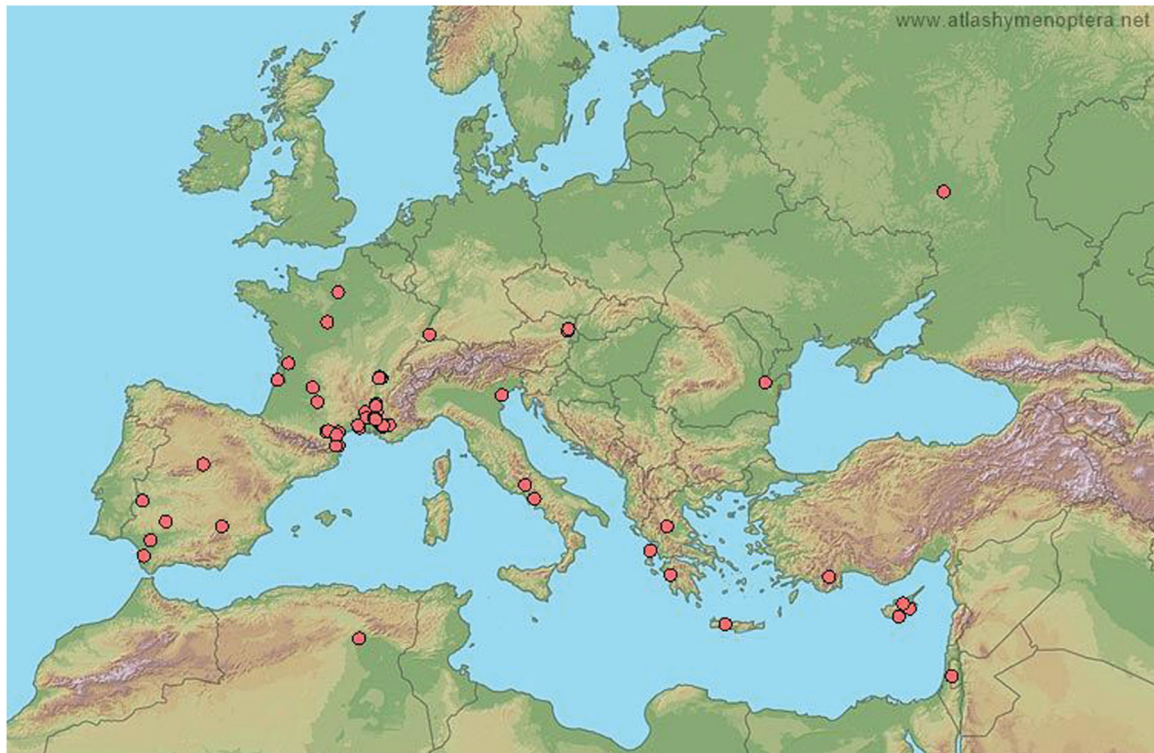

Fig. 21. Fringe on sternum 5 of males (arrow showing the fringe). **A.** *Lasioglossum villosulum* (Kirby, 1802). **B.** *L. medinai* (Vachal, 1895).



A



B

Fig. 22. Geographical distribution of the two pseudocryptic species in the Western Palearctic. **A.** *Lasioglossum villosulum* (Kirby, 1802). **B.** *L. medinai* (Vachal, 1895).

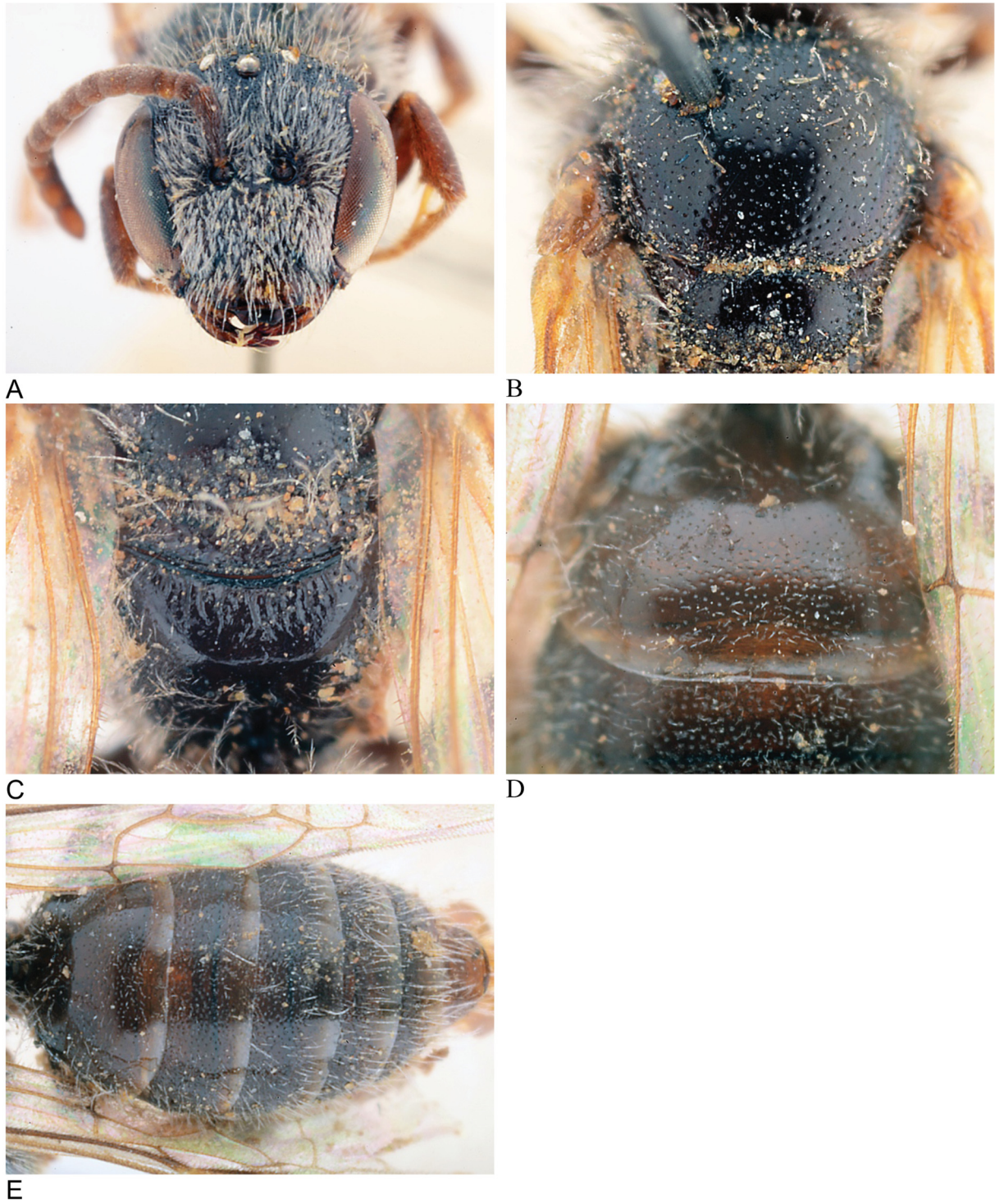

Fig. 23. *Lasioglossum berberum* (Benoist, 1941), holotype, ♂. **A.** Head. **B.** Scutum. **C.** Propodeum. **D.** First tergum. **E.** Metasoma.

Discussion

Morphological examination and DNA analyses allowed the discrimination of *L. medinai* and *L. berberum* from all specimens of *L. villosulum* studied here. Indeed, *L. medinai* females are generally larger than the *L. villosulum* ones but, as mentioned by Plateaux-Quénu *et al.* (1989), overwintering *L. villosulum* founders sometimes also are as large and are difficult to separate from those of *L. medinai*. The examination of fourteen females of *L. medinai* from a same breeding nest at Uchaux (Vaucluse) provided by Luc Plateaux, as well as the detailed examination of specimens from barcoded areas and from other localities (including DNA barcoded specimens), allowed the discovery of subtle morphological characters of punctuation to separate both species, as mentioned in the diagnosis above. Males identified as *L. medinai* by their larger size and denser punctuation of the scutum also show a stronger apical fringe on sternum 5, also some diagnostic and subtle differences in the genitalia as mentioned above (unfortunately the ventral membrane of the gonocoxite is often folded, which hinders the examination of its shape).

Our phylogenetics analyses and species delimitation methods consistently recognize *L. medinai* and *L. berberum* as distinct species from *L. villosulum*. The different lineages identified within *L. villosulum* either were recovered as a monophyletic group, sister to *L. medinai* and *L. berberum* (ultrametric BI, Fig. 4) or formed an unresolved polytomy (ML and BI trees, Fig. 3). They were not recovered as paraphyletic in relation to the clade of *L. medinai* and *L. berberum* in any analysis. Since no morphological characters were found to distinguish the different lineages of *L. villosulum*, we see no reason to further split this species.

Interestingly, the bPTP and GMYC species delimitation approaches suggests candidate species that are undistinguishable by morphology. This is the case for *L. medinai* and *L. villosulum*, which are split in different candidate cryptic species in the bPTP analysis and some GMYC analyses. These methods may oversplit the data (Luo *et al.* 2018; Pentinsaari *et al.* 2017) and may consider intraspecific lineages as candidate species. This could be the case for haplotypes XI and XVI (Table 3) whose specimens were collected in the Middle-East region (Turkey and Israel) and which are considered to form a distinct candidate species within *L. medinai* in all bPTP and the GMYC analyses suggesting > 6 candidate species.

The clade of *L. medinai* included two sequences from GenBank labelled as *L. villosulum* (labels highlighted in red colour in Fig. S1A). These corresponded to one of the three Barcode Index Numbers (or BINs, Ratnasingham & Hebert 2013) identified by Schmidt *et al.* (2015) for *L. villosulum*. A BIN is defined as a unique identifier for a sequence cluster and is obtained by an automatic structuring of DNA barcodes into possible species. Our new COI sequences of *L. villosulum* and *L. medinai* allow us to associate this BIN to *L. medinai*. We think that these sequences might come from specimens of *L. medinai* and which were not identified as such because *L. medinai* was probably considered as a synonym of *L. villosulum* when the specimens were identified. Five other BOLD records (identified as “Hymenoptera” or “*Lasioglossum* n. sp.”), clustered with cluster A (Fig. S1) and may also belong to *L. medinai*. The same logic applies to the other non-morphologically identified specimens whose DNA barcodes are found in the other clusters (Fig. S1).

Additional specimens from the eastern Mediterranean and from Asia (including the subspecies *arabicum* and *trichopse*) combined with their floral preferences, as well as additional DNA markers, would be interesting to analyse. Such a complementary study would provide a better understanding of the systematics and population structure of the *L. villosulum* species complex that has such a wide geographical distribution. *L. villosulum*, *L. medinai* and *L. berberum* are sympatric but the first species is widespread throughout Europe, while the second one has a more Mediterranean or sub-Mediterranean distribution (Fig. 22) and the last one probably North-African distribution.

Other cryptic or pseudocryptic species of Halictidae may be discovered in Europe in the future, thanks to molecular analyses. In this bee family, molecular analysis enables the identification of females of several species that are indistinguishable by morphology, whereas males generally have species-specific traits in genitalia (Pauly *et al.* 2015). Therefore, we advocate for developing a DNA library on a European scale, to obtain reliable identifications of halictid bee species.

Acknowledgments

We thank Mercedes Paris (MNCN) for the loan of the type of *Halictus medinai* Vachal, Patricia Peeters (SMF) for the loan of the type of *H. hirtellus*, Viola Richter (MNHUB) for the type of *H. pauperatulellus*, Corey Smith (AMNH) for the type of *H. rufotegularis*, Agnèle Touret-Alby (MNHN) for the types of *H. villiersi* and *H. berberus*, Holger Dathe (SDEI) for the types of *Lasioglossum villosulum arabicum*. We also thank Frederic Francis and Jeanine Bortels (GABT), Yael Mandelik and Gideon Pisanty (HUJ), Bernard Vaissière and Laurent Guilbaud (INRA), Hadjer Chichoune (University of Constantine, Algeria), Abdeljalil Louar (Algeria), David Genoud (Arzens, Aude, France), Olivier Durand (Beaupréau-en-Mauges, Maine-et-Loire, France), Christophe Philippe (Cahors, Lot, France), Natasha de Manincor (ARSENIC project) and François Javier Ortiz-Sanchez (Almeria, Spain) for the loan of specimens. Luc Plateaux and Cécile Plateaux-Quénu have kindly provided us with specimens of both species from breeding nests, as well as copies of their publications on the subject. Professor Laurence Packer provided us with useful barcode sequences of *L. villosulum*. We thank Jason Gibbs and Laurence Packer, as well as a third anonymous referee, for all the comments to improve the manuscript.

Part of this research has been co-financed by the BELBEES project (Multidisciplinary assessment of BELgian wild BEE decline to adapt mitigation management policy; BELSPO - BR/132/A1/BELBEES). DNA analysis was carried out by the Joint Experimental Molecular Unit (JEMU), funded by the Belgian Science Policy.

References

- Amiet F., Herrmann M., Müller A. & Neumeyer R. 2001. *Apidae* 3. Halictus, Lasioglossum. Fauna Helvetica 3, Centre suisse de Cartographie de la Faune, Neuchâtel.
- Azuma S. & Kinjo M. 1987. *Checklist of the Insects of Okinawa*. Flora and fauna in Okinawa 1, University Ryukyus Nishihara, Okinawa.
- Benoist R. 1941. Récoltes de R. Paulian et A. Villiers dans le Haut Atlas Marocain, 1938 (18. Note). Hyménoptères Apidés. *Annales de la Société entomologique de France* 110: 79–82.
- Blüthgen P. 1920. Die deutschen Arten der Bienengattung *Halictus* Latr. (Hym.). *Deutsche Entomologische Zeitschrift* 1920: 81–302.
- Blüthgen P. 1922. Beiträge zur Synonymie der Bienengattung *Halictus* Latr. *Deutsche Entomologische Zeitschrift* 1922: 46–66, 316–321.
- Blüthgen P. 1923. Beiträge zur Synonymie der Bienengattung *Halictus* Latr. III. *Deutsche Entomologische Zeitschrift* 1923: 239–242.
- Blüthgen P. 1926. Beiträge zur Kenntnis der indo-malayischen *Halictus* und *Thrincostoma* Arten (Hym. Apidae, Halictini). *Zoologische Jahrbucher Jena (Systematik, Geographie und Biologie der Tiere)* 51: 375–698.
- Blüthgen P. 1928. Beiträge zur Kenntnis der indo-malayischen *Halictus* und *Thrincostoma* - Arten. 1 Nachtrag. *Zoologische Jahrbucher Jena (Systematik, Geographie und Biologie der Tiere)* 54: 343–406.

- Blüthgen P. 1930. *Halictus* Latr. In: Schmiedeknecht O. (ed.) *Die Hymenopteren Nord- und Mitteleuropas*: 729–767. Fischer Verlag, Jena.
- Blüthgen P. 1933. Ein Beitrag zur Kenntnis der Bienenfauna Aegyptens (Hymenoptera: Apidae-Halictidae-Halictinae). *Bulletin de la Société royale entomologique d’Égypte* 1933 (1–3): 14–27.
- Bossert S., Gereben-Krenn B.-A., Neumayer J., Schneller B. & Krenn H.W. 2016. The cryptic *Bombus lucorum* complex (Hymenoptera: Apidae) in Austria: phylogeny, distribution, habitat usage and a climatic characterization based on COI sequence data. *Zoological Studies* 55 (13): 1–15. <https://doi.org/10.6620/ZS.2016.55-13>
- Bouckaert R., Heled J., Kühnert D., Vaughan T., Wu C-H., Xie D., Suchard M.A., Rambaut A. & Drummond A.J. 2014. BEAST 2: a software platform for Bayesian evolutionary analysis. *PLoS Computational Biology* 10 (4): e1003537. <https://doi.org/10.1371/journal.pcbi.1003537>
- Bytinsky-Salz H. & Ebmer A.W. 1974. The Halictidae of Israel (Hymenoptera, Apoidea). II. Genus *Lasioglossum*. *Israel Journal of Entomology* 9: 175–217.
- Cockerell T.D.A. 1938a. Descriptions and Records of Bees - CLXVI. *Annals and Magazine of Natural History Series* 11.1 (1): 79–85. <https://doi.org/10.1080/00222933808526744>
- Cockerell T.D.A. 1938b. Halictine bees from Morocco. *American Museum Novitates* 997: 1–9.
- Dalla Torre C.G. de 1896. *Catalogus Hymenopterorum hucusque descriptorum systematicus et synonymicus. Vol X. Apidae (Anthophila)*. Engelmann, Leipzig.
- Danforth B.N. 1999. Phylogeny of the bee genus *Lasioglossum* (Hymenoptera: Halictidae) based on mitochondrial COI sequence data. *Systematic Entomology* 24 (4): 377–393. <https://doi.org/10.1046/j.1365-3113.1999.00087.x>
- Danforth B.N. 2002. Evolution of sociality in a primitively eusocial lineage of bees. *Proceedings of the National Academy of Sciences* 99 (1): 286–290.
- Dathe H.H. 2009. Order Hymenoptera, superfamily Apoidea. Families Colletidae, Andrenidae, Halictidae, Melittidae, Megachilidae and Apidae. *Arthropod Fauna of the UAE* 2: 335–432.
- Ebmer A.W. 1974. Beiträge zur Kenntnis der Fauna Afghanistans. *Halictus* Latr. et *Lasioglossum* Curt., Halictidae, Apoidea, Hymenoptera. *Časopis Moravského musea v Brně* 59: 183–210.
- Ebmer A.W. 1975. Die Typen und Typoide des Natur-Museum Senckenberg 54 Von Schenck beschriebene Halictidae (Ins.: Hymenoptera: Apoidea). *Senckenbergiana Biologica* 56: 233–246.
- Ebmer A.W. 1976. *Halictus* and *Lasioglossum* aus Marokko. *Linzer biologische Beiträge* 8 (1): 205–288.
- Ebmer A.W. 1978a. Die Halictidae der Mandschurei (Apoidea, Hymenoptera). *Bonner Zoologische Beiträge* 29: 183–221.
- Ebmer A.W. 1978b. Die Bienen der Gattungen *Halictus* Latr., *Lasioglossum* Curt. und *Dufourea* Lep. (Hymenoptera, Halictidae) aus Korea. *Annales Historico-Naturales Musei Nationalis Hungarici* 70: 307–319.
- Ebmer A.W. 1978c. *Halictus*, *Lasioglossum*, *Rophites* und *Systropha* aus dem Iran. *Linzer biologische Beiträge* 10: 1–109.
- Ebmer A.W. 1982. Zur Bienenfauna der Mongolei. Die Arten der Gattungen *Halictus* Latr. und *Lasioglossum* Curt. (Hymenoptera: Halictidae). Ergebnisse der Mongolisch-Deutschen Biologischen Expedition seit 1962, Nr 108. *Mitteilungen aus dem Zoologischen Museum in Berlin* 58(2): 199–227.

- Ebmer A.W. 1988. Kritische Liste der nicht-parasitischen Halictidae Österreichs mit Berücksichtigung aller mitteleuropäischen Arten (Insecta: Hymenoptera: Apoidea: Halictidae). *Linzer biologische Beiträge* 20 (2): 527–711.
- Ebmer A.W. 1996. Asiatische Halictidae, 5. Daten zur Aculeaten-Fauna der Ussuri-Region unter Berücksichtigung der angrenzenden Gebiete (Insecta: Hymenoptera: Apoidea: Halictidae: Halictinae). *Linzer biologische Beiträge* 28 (1): 261–304.
- Ebmer A.W. 2004. Zur Bienenfauna Nepals: Arten der Gattungen *Halictus*, *Lasioglossum* und *Dufourea* (Insecta: Hymenoptera: Apoidea: Halictidae). *Veröffentlichungen Naturmuseum Erfurt* 23: 123–150.
- Ebmer A.W. 2005. Zur Bienenfauna der Mongolei. Die Arten der Gattungen *Halictus* Latr. und *Lasioglossum* Curt. (Insecta: Hymenoptera: Apoidea: Halictidae: Halictinae), Ergänzungen und Korrekturen. *Linzer biologische Beiträge* 37 (1): 343–392.
- Ebmer A.W. 2006. Daten zur Aculeaten-Fauna der Ussuri-Region unter Berücksichtigung der angrenzenden Gebiete - 2 Arten der Gattungen *Halictus*, *Lasioglossum*, *Dufourea*, *Macropis* aus dem Lazovski Zapovednik - Naturreservat Laso (Insecta: Hymenoptera: Apoidea: Halictidae, Melittidae). *Linzer biologische Beiträge* 38 (1): 541–593.
- Ebmer A.W. 2008. Neue Taxa der Gattungen *Halictus* Latreille 1804 und *Lasioglossum* Curtis 1833 (Hymenoptera, Apoidea, Halictidae) aus den Vereinigten Arabischen Emiraten. *Linzer biologische Beiträge* 40 (1): 551–580.
- Ezard T., Fujisawa T. & Barraclough T.G. 2017. *splits: Species' Limits by Threshold Statistics*. R package version 1.0-19/r52. Available from <https://R-Forge.R-project.org/projects/splits/> [accessed 8 Jun. 2019].
- Fellendorf M., Mohra C., Roberts S., Wirtz P. & van der Zanden G. 1999. The bees of Madeira (Hymenoptera, Apoidea). *Bocagiana, Museu Municipal do Funchal (Historia Natural)* 197: 1–17.
- Ferrari R.R. 2019. A revision of *Colletes* Latreille (Hymenoptera: Colletidae: Colletinae) from Brazil, Paraguay and Uruguay. *Zootaxa* 4606 (1): 1–91. <https://doi.org/10.11646/zootaxa.4606.1.1>
- Folmer O., Black M., Hoe W., Lutz R. & Vrijenhoek R. 1994. DNA primers for amplification of mitochondrial cytochrome c oxidase subunit I from diverse metazoan invertebrates. *Molecular Marine Biology and Biotechnology* 3 (5): 294–299.
- Françoso E. & Arias M.C. 2013. Cytochrome c oxidase I primers for corbiculate bees: DNA barcode and mini-barcode. *Molecular Ecology* 13: 844–850. <https://doi.org/10.1111/1755-0998.12135>
- Fujisawa T. & Barraclough T.G. 2013. Delimiting species using single-locus data and the Generalized Mixed Yule Coalescent approach: a revised method and evaluation on simulated data sets. *Systematic Biology* 62: 707–724. <https://doi.org/10.1093/sysbio/syt033>
- Gibbs J. 2018. DNA barcoding a nightmare taxon: assessing barcode index numbers and barcode gaps for sweat bees. *Genome* 61 (1): 21–31. <https://doi.org/10.1139/gen-2017-0096>
- Gibbs J., Brady S.G., Kanda K. & Danforth B.N. 2012. Phylogeny of halictine bees supports a shared origin of eusociality for *Halictus* and *Lasioglossum* (Apoidea: Anthophila: Halictidae). *Molecular Phylogenetics and Evolution* 65 (3): 926–939. <https://doi.org/10.1016/j.ympev.2012.08.013>
- Gibbs J., Packer L., Dumesil S. & Danforth B. 2013. Revision and reclassification of *Lasioglossum* (*Evyllaesus*), *L.* (*Hemihalictus*) and *L.* (*Sphecodogastra*) in Eastern North America (Hymenoptera, Apoidea, Halictidae). *Zootaxa* 3672: 1–117. <https://doi.org/10.11646/zootaxa.3672.1.1>
- Goaga A. 2003. Contribuții la studiul speciilor de Halictide (Apoidea: Halictidae) din Fauna Moldavei. *Complexul Muzeal de Științele Naturii "Ion Borcea" Bacău, Studii și Comunicări* 2000–2003: 181–195.
- Gogala A. 1999. Bee fauna of Slovenia: checklist of species (Hymenoptera Apoidea). *Scopolia* 42: 1–79.

- González-Vaquero R.A. & Roig-Alsina A. 2019. The bee *Ruizanthe della mutabilis* Spinola (Hymenoptera: Halictidae): a very common but poorly known species studied using integrative taxonomy. *Zootaxa* 4563 (1): 191–200. <https://doi.org/10.11646/zootaxa.4563.1.12>
- González-Vaquero R.A., Roig-Alsina A. & Packer L. 2016. DNA barcoding as a useful tool in the systematic study of wild bees of the tribe *Augochlorini* (Hymenoptera: Halictidae). *Genome* 59: 889–898. <https://doi.org/10.1139/gen-2016-0006>
- Haneda Y. 1990. [On the Apoidea (Hymenoptera) of Fukui Prefecture, Japan (4)]. *Entomological Journal of Fukui* 7: 2–10. [In Japanese.]
- Hebert P.D.N., Ratnasingham S., Zakharov E.V., Telfer A.C., Levesque-Beaudin V., Milton M.A., Pedersen S., Jannetta P. & de Waard J.R. 2016. Counting animal species with DNA barcodes: Canadian insects. *Philosophical Transactions of the Royal Society of London B* 371: 20150333. <https://doi.org/10.1098/rstb.2015.0333>
- Hillis D. & Bull J.J. 1993. An empirical test of bootstrapping as a method for assessing confidence in phylogenetic analysis. *Systematic Biology* 42 (2): 182–192.
- Huelsenbeck J.P. & Rannala B. 2004. Frequentist properties of Bayesian posterior probabilities of phylogenetic trees under simple and complex substitution models. *Systematic Biology* 53 (6): 904–913.
- Kirby W. 1802. *Monographia Apum Angliae*. Vols 1–2. Privately published, Ipswich.
- Kress W.J., Garcia-Robledo C., Uriarte M. & Erickson D.L. 2015. DNA barcodes for ecology, evolution, and conservation. *Trends in Ecology & Evolution* 30 (1): 25–35. <https://doi.org/10.1016/j.tree.2014.10.008>
- Kumar S., Stecher G. & Tamura K. 2016. MEGA7: Molecular Evolutionary Genetics Analysis Version 7.0 for Bigger Datasets. *Molecular Evolutionary Genetics Analysis* 33 (7): 1870–1874. <https://doi.org/10.1093/molbev/msw054>
- Lajus D., Sukhikh N. & Alekseev V. 2015. Cryptic or pseudocryptic: can morphological methods inform copepod taxonomy? An analysis of publications and a case study of the *Eurytemora affinis* species complex. *Ecology and Evolution* 5 (12): 2374–2385. <https://doi.org/10.1002/ece3.1521>
- Landaverde-González P., Moo-Valle H., Murray T.E., Paxton R.J., Quezada-Euan J.J.G. & Husemann M. 2017. Sympatric lineage divergence in cryptic Neotropical sweat bees (Hymenoptera: Halictidae: *Lasioglossum*). *Organisms Diversity & Evolution* 17: 251–265. <https://doi.org/10.1007/s13127-016-0307-1>
- Lanfear R., Calcott B., Ho S.Y. & Guindon S. 2012. PartitionFinder: combined selection of partitioning schemes and substitution models for phylogenetic analyses. *Molecular Biology and Evolution* 29 (6): 1695–1701. <https://doi.org/10.1093/molbev/mss020>
- Lanfear R., Frandsen P.B., Wright A.M., Senfeld T. & Calcott B. 2017. PartitionFinder 2: new methods for selecting partitioned models of evolution for molecular and morphological phylogenetic analyses. *Molecular Biology and Evolution* 34 (3): 772–773. <https://doi.org/10.1093/molbev/msw260>
- Larkin M.A., Blackshields G., Brown N.P., Chenna R., McGerrigan P.A., McWilliam H., Valentin F., Wallace I.M., Wilm A., Lopez R., Thomson J.D., Gibson T.J. & Higgins D.G. 2007. Clustal W and Clustal X version 2.0. *Bioinformatics* 23 (1): 2947–2948. <https://doi.org/10.1093/bioinformatics/btm404>
- Levchenko T.V. 2015. Contributions to the fauna of bees (Hymenoptera: Apoidea) of Moscow Province. 5. Family Halictidae. Genera *Lasioglossum* Curtis, 1833 and *Evylyaeus* Robertson, 1902. *Eversmannia* 43–44: 20–43.

- Luo A., Ling C., Ho S.Y.W & Zhu C.D. 2018. Comparison of methods for molecular species delimitation across a range of speciation scenarios. *Systematic Biology* 67: 830–846. <https://doi.org/10.1093/sysbio/syy011>
- Magnacca K.N. & Brown M.J. 2012. Barcoding a regional fauna: Irish solitary bees. *Molecular Ecology Research* 12: 990–998. <https://doi.org/10.1111/1755-0998.12001>
- Michonneau F. 2016. *Using GMYC for Species Delineation*. Available from <https://zenodo.org/record/838260#.XPuNfi-B3Vo> [accessed 25 March 2019].
- Michonneau F., Bolker B., Holder M., Lewis P. & O’Meara B. 2018. *rncl: An Interface to the Nexus Class Library. R package version 0.8.3*. Available from <https://CRAN.R-project.org/package=rncl> [accessed 8 Jun. 2019].
- Murao R. 2017. Bees of the *Hemihalictus* series of *Lasioglossum* Curtis (Hymenoptera, Halictidae) in South Korea. *Zootaxa* 4268 (4): 451–488. <https://doi.org/10.11646/zootaxa.4268.4.1>
- Natural History Museum. 2014. Dataset: Collection specimens. Resource: Specimens. *Natural History Museum Data Portal*. <https://doi.org/10.5519/0002965> [accessed 25 Nov. 2018].
- Ortiz-Sánchez F.J. & Pauly A. 2017. Contribution à la connaissance des Halictinae d’Espagne, avec un atlas des espèces de la Péninsule Ibérique (Hymenoptera: Apoidea: Halictidae). *Belgian Journal of Entomology* 54: 1–92.
- Packer L., Porsa A., Plateaux-Quénu C. & Plateaux L. 1999. A cryptic species allied to *Evyllaenus villosulus* (Kirby) (Hymenoptera: Halictidae). *Annales de la Société entomologique de France (N.S.)* 35 (2): 165–171.
- Padial J.M., Miralles A., De la Riva I. & Vences M. 2010. The integrative future of taxonomy. *Frontiers in Zoology* 7 (1): 1–14. <https://doi.org/10.1186/1742-9994-7-16>
- Paradis E. 2010. Pegas: an R package for population genetics with an integrated-modular approach. *Bioinformatics* 26: 419–420.
- Paradis E. & Schliep K. 2018. Ape 5.0: an environment for modern phylogenetics and evolutionary analyses in R. *Bioinformatics* 35 (1): 526–528. <https://doi.org/10.1093/bioinformatics/bty633>
- Pauly A. & Belval S. 2017. Atlas des Halictidae de France (Hymenoptera: Apoidea). *Belgian Journal of Entomology* 53: 1–34.
- Pauly A., Devalez J., Sonet G., Nagy Z.T. & Boevé J.-L. 2015. DNA barcoding and male genital morphology reveal five new cryptic species in the West Palearctic bee *Seladonia smaragdula* (Vachal, 1895) (Hymenoptera: Apoidea: Halictidae). *Zootaxa* 4034 (2): 257–290. <https://doi.org/10.11646/zootaxa.4034.2.2>
- Pentinsaari M., Vos R. & Mutanen M. 2017. Algorithmic single-locus species delimitation: effects of sampling effort, variation and nonmonophyly in four methods and 1870 species of beetles. *Molecular Ecology Resources* 17: 393–404. <https://doi.org/10.1111/1755-0998.12557>
- Pesenko Y.A. 2007a. Subgeneric classification of the Palearctic bees of the genus *Evyllaenus* Robertson (Hymenoptera: Halictidae). *Zootaxa* 1500: 1–54.
- Pesenko Y.A. 2007b. A taxonomic study of the bee genus *Evyllaenus* Robertson of Eastern Siberia and the Far East of Russia (Hymenoptera: Halictidae). *Zoosystematica Rossica* 16: 79–123.
- Pesenko Y., Banaszak J., Radchenko V. & Cierzniaak T., 2000. *Bees of the Family Halictidae (excluding Sphecodes) of Poland: Taxonomy, Ecology, Bionomics*. University Publishers of the Pedagogical School, Bydgoszcz, Poland.

- Plateaux-Quénu C. 1993. Modalités de la socialisation chez les Halictinae (Hymenoptera, Halictidae). I. Biologie des Halictinae. *Année biologique* 32 (4): 183–204.
- Plateaux-Quénu C. & Plateaux L. 1981. La variation individuelle d'*Evyllaesus villosulus* (K.), espèce solitaire (Hym. Halictinae). I. Fondatrices de printemps. *Annales des Sciences naturelles, Zoologie* 13^e Série 3: 249–258.
- Plateaux-Quénu C. & Plateaux L. 1985. La variation individuelle d'*Evyllaesus villosulus* (K.), espèce solitaire (Hym., Halictinae). Comparaison des fondatrices de printemps et de leurs filles, appartenant à la première génération. *Actes des Colloques Insectes sociaux* 2: 293–302.
- Plateaux-Quénu C. & Plateaux L. 1986. Alternance de générations chez *Evyllaesus villosulus* (K.) (Hym. Halictinae). *Actes Colloques internationaux U.I.E.I.S., section française* 1985 3: 73–82.
- Plateaux-Quénu C. & Plateaux L. 1987. Présence de fondatrices géantes dans deux populations d'*Evyllaesus villosulus* (K.) (Hym., Halictinae). *Annales des Sciences naturelles, Zoologie* 13^e série, 1986–1987 8: 259–266.
- Plateaux-Quénu C. & Plateaux L. 1993. Dimorphisme des femelles dans une population d'*Evyllaesus villosulus* (Kirby) (Hym., Halictinae). *Bulletin de la Société zoologique de France* 118 (4): 387–393.
- Plateaux-Quénu C., Plateaux L. & Packer L. 1987. Preadaptations to sociality in the solitary, bivoltine Halictine bee *Evyllaesus villosulus* (K.). *Evolution of Insects Societies. Chemistry and Biology of Social Insects*. J. Peperny, Munich.
- Plateaux-Quénu C., Plateaux L. & Packer L. 1989. Biological notes on *Evyllaesus villosulus* (K.) (Hymenoptera, Halictidae), a bivoltine, largely solitary halictine bee. *Insectes sociaux, Paris* 36 (4): 245–263.
- Pridal A. 2004. Checklist of the bees in the Czech Republic and Slovakia with comments on their distribution and taxonomy (Insecta: Hymenoptera: Apoidea). *Acta Universitatis Agriculturae et Silviculturae Mendelianae Brunensis* 52: 29–65.
- Pons J., Barraclough T.G., Gomez-Zurita J., Cardoso A., Duran D.P., Hazell S., Kamoun S., Sumlin W.D. & Vogler A.P. 2006. Sequence-based species delimitation for the DNA taxonomy of undescribed insects. *Systematic Biology* 55: 1–15. <https://doi.org/10.1080/10635150600852011>
- Praz C., Müller A. & Genoud D. 2019. Hidden diversity in European bees: *Andrena amieti* sp. n., a new Alpine bee species related to *Andrena bicolor* (Fabricius, 1775) (Hymenoptera, Apoidea, Andrenidae). *Alpine Entomology* 3: 11–38. <https://doi.org/10.3897/alpento.3.29675>
- Rambaut A. 2017. *Figtree 1.4.0*. Available from <http://tree.bio.ed.ac.uk/software/figtree/> [accessed 18 Aug. 2017].
- Rambaut A., Drummond A.J., Xie D., Baele G. & Suchard M.A. 2018. Posterior summarisation in Bayesian phylogenetics using Tracer 1.7. *Systematic Biology* 67: 901–904. <https://doi.org/10.1093/sysbio/syy032>
- Rasmussen C., Schmidt H.T. & Madsen H.B. 2016. Distribution, phenology and host plants of Danish bees (Hymenoptera, Apoidea). *Zootaxa* 4212 (1): 1–100. <https://doi.org/10.11646/zootaxa.4212.1.1>
- Ratnasingham S. & Hebert P.D.N. 2013. A DNA-based registry for all animal species: the Barcode Index Number (BIN) system. *PLoS ONE* 8 (7): e66213. <https://doi.org/10.1371/journal.pone.0066213>
- Ronquist F., Teslenko M., van der Mark P., Darling A., Larget B., Liu L., Suchard M.A. & Huelsenbeck J.P. 2012. MrBayes 3.2: Efficient Bayesian phylogenetic inference and model choice across a large model space. *Systematic Biology* 61 (3): 539–542. <https://doi.org/10.1093/sysbio/sys029>

- Schenck A. 1869. Beschreibung der nassauischen Bienen. II. Nachtrag. *Jahrbücher des Nassauischen Vereins für Naturkunde* 21–22 (1867–1868): 301–312 (*Halictus*), 375 (Nachträge).
- Schmidt S., Schmid-Egger C., Morinière J., Haszprunar G. & Hebert P.D.N. 2015. DNA barcoding largely supports 250 years of classical taxonomy: identifications for Central European bees (Hymenoptera, Apoidea partim). *Molecular Ecology Resources* 15 (4): 985–1000.
<https://doi.org/10.1111/1755-0998.12363>
- Simon C., Frati F., Beckenbach A., Crespi B., Hong Liu & Flook P. 1994. Evolution, weighting, and phylogenetic utility of mitochondrial gene sequences and a compilation of conserved polymerase chain reaction primers. *Annals of the Entomological Society of America* 87 (6): 651–701.
- Strand E. 1909. Die paläarktischen *Halictus*-Arten des Kgl. Zoologischen Museums zu Berlin, z.T. nach Bestimmungen von J. D. Alfken. *Archiv für Naturgeschichte* 75 I (1): 1–62.
- Strand E. 1914. H. Sauter Formosa Ausbeute: Apidae II (Die *Halictus*-Arten von Formosa). *Archiv für Naturgeschichte* A 12 (1913): 147–171.
- Struck T.H., Feder J.L., Bendiksbj M., Birkeland S., Cerca J., Gusarov V.I., Kistenich S., Larrson K.-H., Lee Hsiang Liow, Nowak M.D., Stedje B., Bachmann L. & Dimitrov D. 2017. Finding evolutionary processes hidden in cryptic species. *Trends in Ecology & Evolution*: 1–11.
<https://doi.org/10.1016/j.tree.2017.11.007>
- Sukumaran J. & Holder M.T. 2010. DendroPy: a Python library for phylogenetic computing. *Bioinformatics* 26: 1569–1571. <https://doi.org/10.1093/bioinformatics/btq228>
- Sukumaran J. & Holder M.T. 2017. *SumTrees: Phylogenetic Tree Summarization*. Ver. 4.3.0. Available from <https://github.com/jeetsukumaran/DendroPy> [accessed 16 Feb 2018].
- Svensson B.G., Erlandsson S. & Janzon L.-A. 1990. Catalogus Insectorum Sueciae. Hymenoptera, Apoidea. 2. Andrenidae and Halictidae. *Entomologisk Tidskrift* 111: 47–52.
- Takahashi H. & Sakagami S.F. 1993. Notes on the halictine bees (Hymenoptera Apoidea) of the Izu Islands: *Lasioglossum kuroshio* sp. nov., life cycles in Hachijo-jima Is., and a preliminary list of the species in the Izu Islands. *Japanese Journal of Entomology* 61 (2): 267–278.
- Tang C.Q., Humphreys A.M., Fontaneto D., Barraclough T.G. 2014. Effects of phylogenetic reconstruction method on the robustness of species delimitation using single-locus data. *Methods in Ecology and Evolution* 5 (10): 1086–1094. <https://doi.org/10.1111/2041-210X.12246>
- Tang C.Q., Notton D.G., Norman H. & Vogler A. 2018. *Taxonomic Fellowship to Support the National Pollinators Strategy - EVID4 Evidence Project Final Report*. Department for Environment, Food and Rural Affairs and The Natural History Museum, London.
- Usui M., Nishijuma Y., Fukuda H. & Sakagami S.F. 1976. A wild bee survey in Obihiro, eastern Hokkaido. *Research Bulletin of Obihiro University* 10: 225–251.
- Vachal J. 1895. *Halictus* nouveaux de la collection Medina. *Anales de la Sociedad Española de Historia Natural* 24: 147–150.
- Warneke K. 1973. Zur Systematik und Synonymie der mitteleuropäischen Furchenbienen *Halictus* Latreille (Hymenoptera, Apoidea, Halictidae). *Bulletin de la Société royale des Sciences de Liège* 42 (7–8): 277–295.
- Warneke K. 1975a. Beitrag zur Systematik und Verbreitung der Furchenbienen in der Türkei (Hymenoptera, Apoidea, *Halictus*). *Polskie Pismo Entomologiczne* 45: 81–128.
- Warneke K. 1975b. Zur Kenntnis der Bienengattung *Halictus* Latr. auf den Kanarischen Inseln (Hym., Apoidea). *Vieraea* 4: 201–223.

Warncke K. 1976. Bemerkungen zu der Arbeit von Ebmer über die als *Apis* beschriebenen Bienen der Gattung *Halictus* und ein Beitrag zur Namensklärung nordafrikanischer Bienen der gleichen Gattung (Hym. Apidae). *Nachrichtenblatt der Bayerischen Entomologen* 25 (5): 89–96.

Weissmann J.A., Picanço A., Borges P.A.V. & Schaefer H. 2017. Bees of the Azores: an annotated checklist (Apidae, Hymenoptera). *Zookeys* 642: 63–95. <https://doi.org/10.3897/zookeys.642.10773>

Wilcox T.P., Zwickl D.J., Heath T.A. & Hillis D.M. 2002. Phylogenetic relationships of the dwarf boas and a comparison of Bayesian and bootstrap measures of phylogenetic support. *Molecular Phylogenetics and Evolution* 25: 361–371. [https://doi.org/10.1016/S1055-7903\(02\)00244-0](https://doi.org/10.1016/S1055-7903(02)00244-0)

Zhang J., Kapli P., Pavlidis P. & Stamatakis A. 2013. A general species delimitation method with applications to phylogenetic placements. *Bioinformatics* 29 (22): 2869–2876. <https://doi.org/10.1093/bioinformatics/btt499>

Zwickl D.J. 2006. *Genetic Algorithm Approaches for the Phylogenetic Analysis of Large Biological Sequence Datasets under the Maximum Likelihood Criterion*. Ph.D. dissertation, *The University of Texas at Austin*. Available from <http://hdl.handle.net/2152/2666> [accessed 4 Jul. 2019].

Manuscript received: 9 April 2018

Manuscript accepted: 28 June 2019

Published on: 1 August 2019

Topic editor: Gavin Broad

Desk editor: Kristiaan Hoedemakers

Printed versions of all papers are also deposited in the libraries of the institutes that are members of the *EJT* consortium: Muséum national d'Histoire naturelle, Paris, France; Meise Botanic Garden, Belgium; Royal Museum for Central Africa, Tervuren, Belgium; Royal Belgian Institute of Natural Sciences, Brussels, Belgium; Natural History Museum of Denmark, Copenhagen, Denmark; Naturalis Biodiversity Center, Leiden, the Netherlands; Museo Nacional de Ciencias Naturales-CSIC, Madrid, Spain; Real Jardín Botánico de Madrid CSIC, Spain; Zoological Research Museum Alexander Koenig, Bonn, Germany; National Museum, Prague, Czech Republic.